



VS 6" - 8" SERIES 50 HZ

STAINLESS STEEL SUBMERSIBLE PUMPS
FOR 6" AND 8" DEEP WELLS OR LARGER



INDEX

6" STAINLESS STEEL SUBMERSIBLE PUMPS	4
Family curves.....	5
Pump identification code.....	5
Pumps and motors range.....	6
Materials/fluids compatibility.....	7
TABLE OF HYDRAULIC PERFORMANCE AT 50 HZ	8
VS 14.....	8
VS 19.....	9
VS 25 *.....	10
VS 30.....	11
VS 46.....	12
VS 65.....	13
TECHNICAL DATA AND PERFORMANCE CURVES AT 50 HZ	14
VS 14.....	14
VS 14 High pressure.....	18
VS 19.....	20
VS 19 High pressure.....	24
VS 25*.....	26
VS 30.....	28
VS 30 HIGH PRESSURE.....	32
VS 46.....	34
VS 46 High pressure.....	36
VS 65.....	38
VS 65 High pressure.....	40
SPARE PARTS	42
VS 14-19-25*.....	42
VS 30-46-65.....	43
MOTOR ADAPTER AND DIMENSIONS.....	44
VS 14-19-25*.....	44
VS 30-46-65.....	45
8" STAINLESS STEEL SUBMERSIBLE PUMPS	48
Family curves.....	49
Pump identification code.....	49
Pumps and motors range.....	49
Materials/fluids compatibility.....	50
HYDRAULIC PERFORMANCE AT 50 HZ.....	51
VS 78.....	51
VS 97.....	51
TECHNICAL DATA AND PERFORMANCE CURVES AT 50 HZ	52
VS 78.....	52
VS 97.....	54
SPARE PARTS	56
VS 78-97.....	56
MOTOR ADAPTER AND DIMENSIONS.....	57
VS 78-97.....	57

* IMPORTANT: VS25 models only for sales out of EU or as a component of fire-fighting units

NOTE: Franklin Electric S.r.l. reserves the right to amend specification without prior notice



VS 6" Series

50 Hz

VS 14 - 19 - 25* - 30 - 46 - 65

* IMPORTANT: VS25 models only for sales out of EU or as a component of fire-fighting units

6" STAINLESS STEEL SUBMERSIBLE PUMPS

APPLICATION

- Municipal water works
- Water distribution and pressure boosting
- Irrigation and sprinkler systems, water treatment plants, filtration and reverse osmosis
- Industrial cooling and processing
- Mining industry, drainage and dewatering
- Fire-fighting equipment
- Fountains

FEATURES

- Fabricated stainless steel impellers and diffusers for corrosion resistance
- Heavy-duty stainless-steel structure for improved stiffness and ensuring the permanent alignment of all components and thus increased run time and trouble-free operation
- Floating Neck ring in PPS (14-19-25*) or in PTFE (30-46-65)
- Reinforced version with double welded rings for high pressure pumps
- Compact, reliable and suited to operate in horizontal position
- Built-in check valve to protect the pump against water hammer risk
- The hydraulic design is such to enhance the overall efficiency thus reducing energy consumption and making the pumping systems more cost effective

PUMP SPECIFICATION

- Flow: up to 80 m³/h at 50 Hz
- Head: up to 700 m (70 Bar) at 50 Hz
- Water temperature range:
 - Minimum: -5 °C
 - Maximum: +90 °C (+60 °C for NBR parts)
- Maximum allowable amount of sand 100 g/m³
- Rotation: counterclockwise when looking into the discharge
- Pump can work continuously in vertical or horizontal position

MOTOR SPECIFICATION

- Motor adapter in compliance with NEMA standard
- For more information consult the product catalog of Submersible motors

AVAILABLE ON REQUEST

- Pump material:
 - 316 Stainless steel (N) version (DIN/EN 1.4401)
 - 904L (R) version (DIN/EN 1.4539)
 - See specified material variant in "Materials/Fluids compatibility" table on page 7
- Double cable guard (SD version)
- Discharge heads:
 - Rp 2" (with kit adapter 2"1/2-2" PN 14251008) and Rp 3" for 14 and 19 l and N versions
 - Rp 4" for 25*-30-46-65 l and N versions
- Motor adapter:
 - 4" for l and N version
 - 8" for l and N version
- Pump with NBR rubber parts

FAMILY CURVES

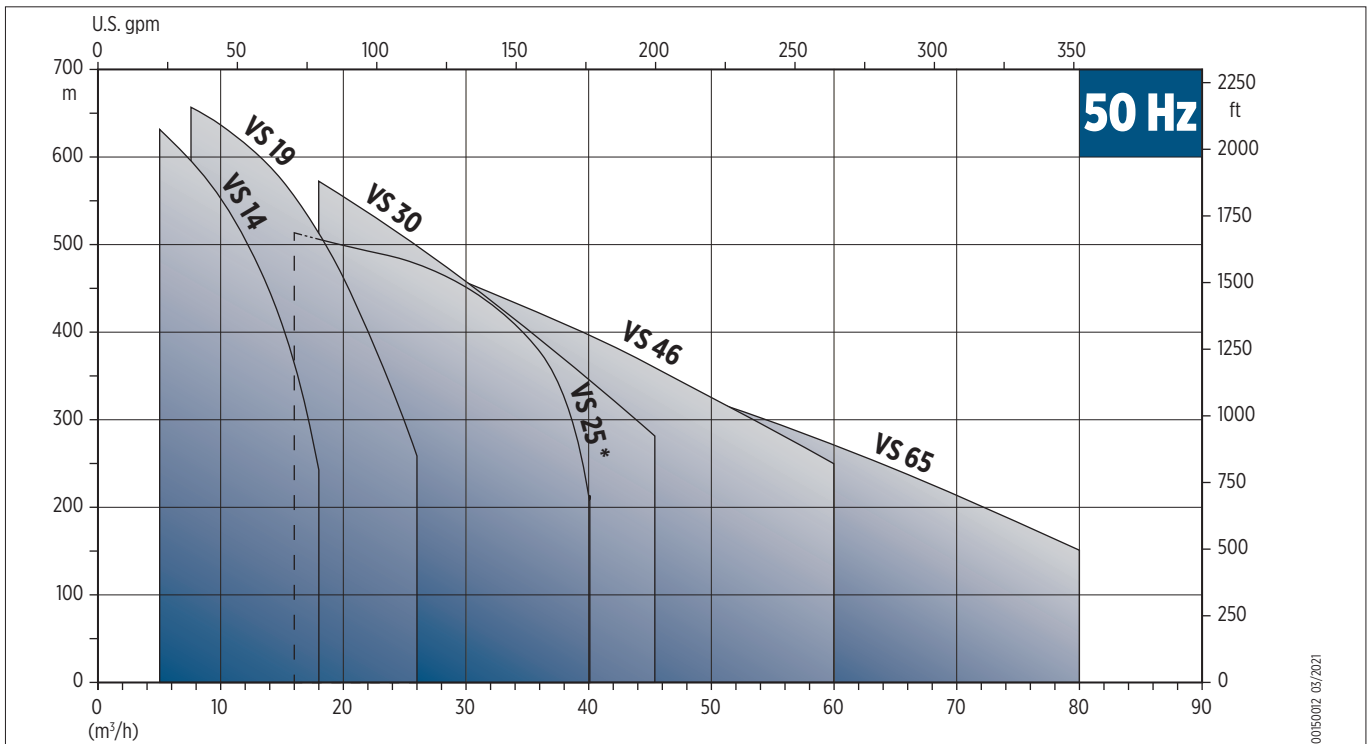

PUMP IDENTIFICATION CODE

VS 14 / 15 I M6 RP5 E1 P HP SD

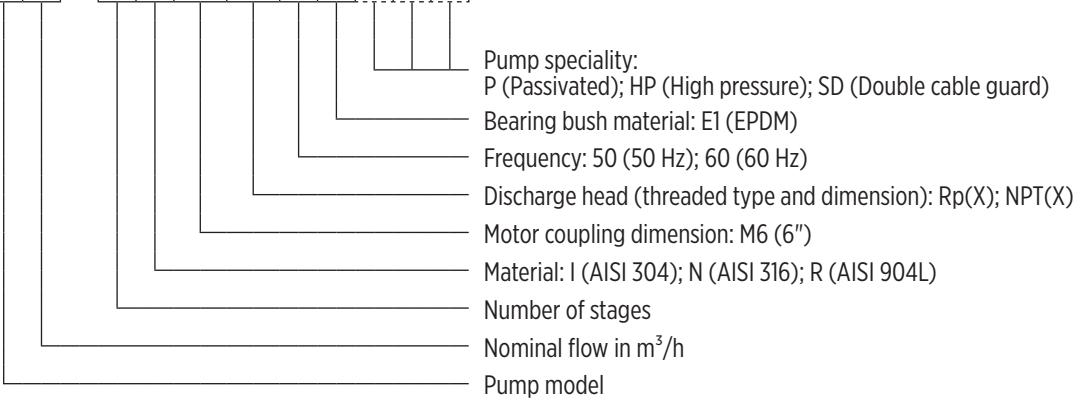

00140010 06/2021

* IMPORTANT: VS25 models only for sales out of EU or as a component of fire-fighting units



PUMPS AND MOTORS RANGE

Type	Versions			Motor power range [kW]	
	I EN 1.4301	N EN 1.4401	R EN 1.4539	I e N	R
	VS14	○	○	-	4 ÷ 30
VS19	○	○	-	4 ÷ 37	-
VS25 *	○	○	-	4 ÷ 45	-
VS30	○	○	●	3 ÷ 55	4 ÷ 37
VS46	○	○	●	3.7 ÷ 55	4 ÷ 37
VS65	○	○	●	3.7 ÷ 55	4 ÷ 37

○ = Version available ● = Version available only with 6" motor coupling

* IMPORTANT: VS25 models only for sales out of EU or as a component of fire-fighting units

MATERIALS/FLUIDS COMPATIBILITY

Ref. No.	Parts description	Material	Standard					
			I Version		N Version		R Version	
			ASTM	DIN/EN	ASTM	DIN/EN	ASTM	DIN/EN
10.00	Discharge head	Stainless steel	CF8 (304)	1.4308	CF8M (316)	1.4408	CD4MCuN (904L)	1.4517
10.01 10.04 10.05	Valve	Stainless steel	316	1.4401	316	1.4401	2205/904L	1.4462/1.4460
10.02	Sealing O-ring		EPDM					
10.03	Outer case locking nuts	Stainless steel	316	1.4401	316	1.4401	2205	1.4462
20.00	Outer case	Stainless steel	304	1.4301	316	1.4401	2205	1.4462
20.01	Suction strainer	Stainless steel	316	1.4401	316	1.4401	904L	1.4539
20.02	Cable guard and screws	Stainless steel	316	1.4401	316	1.4401	904L	1.4539
20.03	Initial spacer	Stainless steel	304	1.4301	316	1.4401	904L	1.4539
20.04	Flange	Stainless steel	CF8 (304)	1.4308	CF8M (316)	1.4408	CD4MCuN (904L)	1.4517
	Screws		304	1.4301	316	1.4401	904L	1.4539
20.05	Motor adapter	Stainless steel	CF8 (304)	1.4308	CF8M (316)	1.4408	CD4MCuN (904L)	1.4517
20.06	4" motor flange	Stainless steel	CF8M (316)	1.4408	CF8M (316)	1.4408	-	-
	4" coupling adapter		316	1.4401	316	1.4401		
20.07	8" motor adapter (30/46/65)	Stainless steel	CF8M (316)	1.4408	CF8M (316)	1.4408	-	-
	Bolts and washers (30/46/65)		316	1.4401	316	1.4401		
30.00	Pump shaft	Stainless steel	431	1.4057	316/329	1.4401/1.4460	329	1.4460
30.01	Coupling	Stainless steel	431/329	1.4057/1.4460	316/329	1.4401/1.4460	904L/329	1.4462/1.4539 1.4460
30.02	Upper up-thrust washer	Stainless steel	316	1.4401	316	1.4401	329	1.4460
30.03	Lower up-thrust washer	Stainless steel	316	1.4401	316	1.4401	329	1.4460
30.04	Upper journal sleeve	Alluminum Oxide	Al2 O3 (99,7%)					
30.05	Screw and washer	Stainless steel	316	1.4401	316	1.4401	904L/329	1.4539/1.4460
30.06	Up-thrust ring		PTFE + Grafite					
30.07 30.08	Lower / Upper spacer	Stainless steel	316	1.4401	316	1.4401	-	-
40.00	Diffuser	Stainless steel	304	1.4301	316	1.4401	904L	1.4539
40.01	Secondary bearing bush		EPDM					
40.02	Floating neck ring		PPS (14/19/25)					
			PTFE (30/46/65)					
40.03	Flange clamping neck ring (30/46/65)	Stainless steel	304	1.4301	316	1.4401	904L	1.4539
40.04	Bearing bush		EPDM					
40.05	Upper bearing guide (14/19/25*)	Stainless steel	CF8M (316)	1.4408	CF8M (316)	1.4408	-	-
	Last - Intermediate diffuser (30/46/65)		316	1.4401	316	1.4401	904L	1.4539
40.06	First diffuser (14/19/25*)	Stainless steel	316	1.4401	316	1.4401	-	-
40.07	Diffuser with upper up-thrust washer (14/19/25*)	Stainless steel	316	1.4401	316	1.4401	-	-
40.08	Last diffuser (14/19/25*)	Stainless steel	316	1.4401	316	1.4401	-	-
50.00	Impeller	Stainless steel	304	1.4301	316	1.4401	904L	1.4539
50.05	Wear ring	Stainless steel	304	1.4301	316	1.4401	904L	1.4539
50.01	Impeller spacer (14/19/25*)	Stainless steel	316	1.4401	316	1.4401	329	1.4460
51.01	Split cone (30/46/65)	Stainless steel	316	1.4401	316	1.4401	329	1.4460
51.02	Split cone nut (30/46/65)	Stainless steel	316	1.4401	316	1.4401	329	1.4460
51.03	Intermediate cone nut (30/46/65)	Stainless steel	316	1.4401	316	1.4401	329	1.4460
		Alluminum Oxide	Al2 O3 (99,7%)					
51.04	Up-thrust split cone nut (30/46/65)	Stainless steel	316	1.4401	316	1.4401	329	1.4460
51.06	Intermediate impeller with screw (30/46/65)	Stainless steel	304	1.4301	316	1.4401	904L	1.4539

* IMPORTANT: VS25 models only for sales out of EU or as a component of fire-fighting units

TABLE OF HYDRAULIC PERFORMANCE AT 50 Hz

VS 14

Pump model	RATED POWER		Q = DELIVERY						
			m ³ /h 0	6	8	10	12	15	18
	[kW]	[HP]	l/min 0	100	133	167	200	250	300
H = TOTAL METERS HEAD OF WATER COLUMN [m]									
VS 14/5	4	5.5	56.1	50.7	48.4	45.4	41.4	31.3	18.6
VS 14/6	4	5.5	67.3	60.8	58.1	54.5	49.7	37.5	22.3
VS 14/7	4	5.5	78.5	71.0	67.8	63.6	58.0	43.8	26.0
VS 14/8	4	5.5	89.7	81.1	77.5	72.7	66.3	50.0	29.7
VS 14/9	5.5	7.5	100.9	91.2	87.2	81.8	74.6	56.3	33.4
VS 14/10	5.5	7.5	112.1	101.4	96.9	90.9	82.9	62.5	37.1
VS 14/11	5.5	7.5	123.3	111.5	106.6	100.0	91.2	68.8	40.8
VS 14/12	5.5	7.5	134.6	121.7	116.3	109.1	99.5	75.0	44.6
VS 14/13	5.5	7.5	145.8	131.8	125.9	118.1	107.7	81.3	48.3
VS 14/14	7.5	10	157.0	141.9	135.6	127.2	116.0	87.5	52.0
VS 14/15	7.5	10	168.2	152.1	145.3	136.3	124.3	93.8	55.7
VS 14/16	7.5	10	179.4	162.2	155.0	145.4	132.6	100.0	59.4
VS 14/17	7.5	10	190.6	172.3	164.7	154.5	140.9	106.3	63.1
VS 14/18	9.3	12.5	201.8	182.5	174.4	163.6	149.2	112.5	66.8
VS 14/19	9.3	12.5	213.0	192.6	184.1	172.7	157.5	118.8	70.5
VS 14/20	9.3	12.5	224.3	202.8	193.8	181.8	165.8	125.0	74.3
VS 14/21	9.3	12.5	235.5	212.9	203.4	190.8	174.0	131.3	78.0
VS 14/22	9.3	12.5	246.7	223.0	213.1	199.9	182.3	137.5	81.7
VS 14/23	11	15	257.9	233.2	222.8	209.0	190.6	143.8	85.4
VS 14/24	11	15	269.1	243.3	232.5	218.1	198.9	150.0	89.1
VS 14/25	11	15	280.3	253.4	242.2	227.2	207.2	156.3	92.8
VS 14/26	11	15	291.5	263.6	251.9	236.3	215.5	162.5	96.5
VS 14/27	15	20	302.7	273.7	261.6	245.4	223.8	168.8	100.2
VS 14/28	15	20	314.0	283.9	271.3	254.5	232.1	175.0	104.0
VS 14/29	15	20	325.2	294.0	280.9	263.5	240.3	181.3	107.7
VS 14/30	15	20	336.4	304.1	290.6	272.6	248.6	187.5	111.4
VS 14/31	15	20	347.6	314.3	300.3	281.7	256.9	193.8	115.1
VS 14/32	15	20	358.8	324.4	310.0	290.8	265.2	200.0	118.8
VS 14/33	15	20	370.0	334.5	319.7	299.9	273.5	206.3	122.5
VS 14/34	15	20	381.2	344.7	329.4	309.0	281.8	212.5	126.2
VS 14/35	15	20	392.4	354.8	339.1	318.1	290.1	218.8	129.9
VS 14/36	15	20	403.7	365.0	348.8	327.2	298.4	225.0	133.7
VS 14/37	18.5	25	414.9	375.1	358.4	336.2	306.6	231.3	137.4
VS 14/38	18.5	25	426.1	385.2	368.1	345.3	314.9	237.5	141.1
VS 14/39	18.5	25	437.3	395.4	377.8	354.4	323.2	243.8	144.8
VS 14/40	18.5	25	448.5	405.5	387.5	363.5	331.5	250.0	148.5
VS 14/41	18.5	25	459.7	415.6	397.2	372.6	339.8	256.3	152.2
VS 14/42	18.5	25	470.9	425.8	406.9	381.7	348.1	262.5	155.9
VS 14/43	18.5	25	482.1	435.9	416.6	390.8	356.4	268.8	159.6
VS 14/44	18.5	25	493.4	446.1	426.3	399.9	364.7	275.0	163.4
VS 14/45	22	30	504.6	456.2	435.9	408.9	372.9	281.3	167.1
VS 14/46	22	30	515.8	466.3	445.6	418.0	381.2	287.5	170.8
VS 14/47	22	30	527.0	476.5	455.3	427.1	389.5	293.8	174.5
VS 14/48	22	30	538.2	486.6	465.0	436.2	397.8	300.0	178.2
VS 14/49	22	30	549.4	496.7	474.7	445.3	406.1	306.3	181.9
VS 14/50	22	30	560.6	506.9	484.4	454.4	414.4	312.5	185.6
VS 14/51	22	30	571.8	517.0	494.1	463.5	422.7	318.8	189.3
VS 14/52	22	30	583.1	527.2	503.8	472.6	431.0	325.0	193.1
VS 14/53	30	40	594.3	537.3	513.4	481.6	439.2	331.3	196.8
VS 14/54	30	40	605.5	547.4	523.1	490.7	447.5	337.5	200.5
VS 14/55	30	40	616.7	557.6	532.8	499.8	455.8	343.8	204.2
VS 14/56	30	40	627.9	567.7	542.5	508.9	464.1	350.0	207.9
VS 14/57	30	40	639.1	577.8	552.2	518.0	472.4	356.3	211.6
VS 14/58	30	40	650.3	588.0	561.9	527.1	480.7	362.5	215.3
VS 14/59	30	40	661.5	598.1	571.6	536.2	489.0	368.8	219.0
VS 14/60	30	40	672.8	608.3	581.3	545.3	497.3	375.0	222.8
VS 14/61	30	40	684.0	618.4	590.9	554.3	505.5	381.3	226.5

VS 19

Pump model	RATED POWER		Q = DELIVERY								
			m ³ /h 0	8	10	12	15	18	21	24	27
	[kW]	[HP]	l/min 0	133	167	200	250	300	350	400	450
H = TOTAL METERS HEAD OF WATER COLUMN [m]											
VS 19/6	4	5.5	70.0	66.5	64.0	62.0	58.0	52.0	43.5	33.0	20.5
VS 19/7	5.5	7.5	81.7	77.5	74.7	72.3	67.2	60.2	50.4	38.4	23.9
VS 19/8	5.5	7.5	93.3	88.5	85.3	82.7	76.8	68.8	57.6	43.9	27.4
VS 19/9	5.5	7.5	105.0	99.6	96.0	93.0	86.4	77.4	64.8	49.4	30.8
VS 19/10	7.5	10	116.7	110.7	106.7	103.3	96.0	86.0	72.0	54.9	34.2
VS 19/11	7.5	10	128.3	121.7	117.3	113.7	105.6	94.6	79.2	60.4	37.6
VS 19/12	7.5	10	140.0	132.8	128.0	124.0	115.2	103.2	86.4	65.8	41.0
VS 19/13	9.3	12.5	151.7	143.9	138.7	134.3	124.8	111.8	93.6	71.3	44.5
VS 19/14	9.3	12.5	163.3	154.9	149.3	144.7	134.4	120.4	100.8	76.8	47.9
VS 19/15	9.3	12.5	175	166	160	155	144	129	108	82.3	51.3
VS 19/16	11	15	186.7	177.1	170.7	165.3	153.6	137.6	115.2	87.8	54.7
VS 19/17	11	15	198.3	188.1	181.3	175.7	163.2	146.2	122.4	93.3	58.1
VS 19/18	11	15	210.0	199.2	192.0	186.0	172.8	154.8	129.6	98.8	61.6
VS 19/19	15	20	221.7	210.3	202.7	196.3	182.4	163.4	136.8	104.2	65.0
VS 19/20	15	20	233.3	221.3	213.3	206.7	192.0	172.0	144.0	109.7	68.4
VS 19/21	15	20	245.0	232.4	224.0	217.0	201.6	180.6	151.2	115.2	71.8
VS 19/22	15	20	256.7	243.5	234.7	227.3	211.2	189.2	158.4	120.7	75.2
VS 19/23	15	20	268.3	254.5	245.3	237.7	220.8	197.8	165.6	126.2	78.7
VS 19/24	15	20	280.0	265.6	256.0	248.0	230.4	206.4	172.8	131.7	82.1
VS 19/25	18.5	25	291.7	276.7	266.7	258.3	240.0	215.0	180.0	137.2	85.5
VS 19/26	18.5	25	303.3	287.7	277.3	268.7	249.6	223.6	187.2	142.7	88.9
VS 19/27	18.5	25	315.0	298.8	288.0	279.0	259.2	232.2	194.4	148.1	92.3
VS 19/28	18.5	25	326.7	309.9	298.7	289.3	268.8	240.8	201.6	153.6	95.8
VS 19/29	18.5	25	338.3	320.9	309.3	299.7	278.4	249.4	208.8	159.1	99.2
VS 19/30	18.5	25	350.0	332.0	320.0	310.0	288.0	258.0	216.0	164.6	102.6
VS 19/31	22	30	361.7	343.1	330.7	320.3	297.6	266.6	223.2	170.1	106.0
VS 19/32	22	30	373.3	354.1	341.3	330.7	307.2	275.2	230.4	175.6	109.4
VS 19/33	22	30	385.0	365.2	352.0	341.0	316.8	283.8	237.6	181.1	112.9
VS 19/34	22	30	396.7	376.3	362.7	351.3	326.4	292.4	244.8	186.5	116.3
VS 19/35	22	30	408.3	387.3	373.3	361.7	336.0	301.0	252.0	192.0	119.7
VS 19/36	22	30	420.0	398.4	384.0	372.0	345.6	309.6	259.2	197.5	123.1
VS 19/37	30	40	431.7	409.5	394.7	382.3	355.2	318.2	266.4	203.0	126.5
VS 19/38	30	40	443.3	420.5	405.3	392.7	364.8	326.8	273.6	208.5	130.0
VS 19/39	30	40	455.0	431.6	416.0	403.0	374.4	335.4	280.8	214.0	133.4
VS 19/40	30	40	466.7	442.7	426.7	413.3	384.0	344.0	288.0	219.5	136.8
VS 19/41	30	40	478.3	453.7	437.3	423.7	393.6	352.6	295.2	225.0	140.2
VS 19/42	30	40	490.0	464.8	448.0	434.0	403.2	361.2	302.4	230.4	143.6
VS 19/43	30	40	501.7	475.9	458.7	444.3	412.8	369.8	309.6	235.9	147.1
VS 19/44	30	40	513.3	486.9	469.3	454.7	422.4	378.4	316.8	241.4	150.5
VS 19/45	30	40	525.0	498.0	480.0	465.0	432.0	387.0	324.0	246.9	153.9
VS 19/46	30	40	536.7	509.1	490.7	475.3	441.6	395.6	331.2	252.4	157.3
VS 19/47	30	40	548.3	520.1	501.3	485.7	451.2	404.2	338.4	257.9	160.7
VS 19/48	30	40	560.0	531.2	512.0	496.0	460.8	412.8	345.6	263.4	164.2
VS 19/49	30	40	571.7	542.3	522.7	506.3	470.4	421.4	352.8	268.8	167.6
VS 19/50	37	50	583.3	553.3	533.3	516.7	480.0	430.0	360.0	274.3	171.0
VS 19/51	37	50	595.0	564.4	544.0	527.0	489.6	438.6	367.2	279.8	174.4
VS 19/52	37	50	606.7	575.5	554.7	537.3	499.2	447.2	374.4	285.3	177.8
VS 19/53	37	50	618.3	586.5	565.3	547.7	508.8	455.8	381.6	290.8	181.3
VS 19/54	37	50	630.0	597.6	576.0	558.0	518.4	464.4	388.8	296.3	184.7
VS 19/55	37	50	641.7	608.7	586.7	568.3	528.0	473.0	396.0	301.8	188.1
VS 19/56	37	50	653.3	619.7	597.3	578.7	537.6	481.6	403.2	307.3	191.5
VS 19/57	37	50	665.0	630.8	608.0	589.0	547.2	490.2	410.4	312.7	194.9
VS 19/58	37	50	676.7	641.9	618.7	599.3	556.8	498.8	417.6	318.2	198.4
VS 19/59	37	50	688.3	652.9	629.3	609.7	566.4	507.4	424.8	323.7	201.8
VS 19/60	37	50	700.0	664.0	640.0	620.0	576.0	516.0	432.0	329.2	205.2

VS 25 *

* IMPORTANT: Models only for sales out of EU or as a component of fire-fighting units

Pump model	RATED POWER		Q = DELIVERY							
			m ³ /h 0	16	20	24	28	32	36	40
	[kW]	[HP]	l/min 0	266	333	400	466	533	600	666
			H = TOTAL METERS HEAD OF WATER COLUMN [m]							
VS 25/3	4	5.5	36.3	32.8	30.7	28.5	25.1	21.0	17.1	12.0
VS 25/4	4	5.5	48.4	43.8	41.0	38.1	33.4	28.0	22.8	16.0
VS 25/5	5.5	7.5	60.5	54.7	51.2	47.6	41.8	35.0	28.5	20.0
VS 25/6	7.5	10	72.6	65.7	61.5	57.1	50.1	42.0	34.2	24.0
VS 25/7	7.5	10	84.7	76.6	71.7	66.6	58.5	49.0	39.9	28.0
VS 25/8	9.3	12.5	96.8	87.5	81.9	76.1	66.9	56.0	45.6	32.0
VS 25/9	9.3	12.5	108.9	98.5	92.2	85.6	75.2	63.0	51.3	36.0
VS 25/10	11	15	121.0	109.4	102.4	95.1	83.6	70.0	57.0	40.0
VS 25/11	11	15	133.1	120.4	112.7	104.7	91.9	77.0	62.7	44.0
VS 25/12	15	20	145.2	131.3	122.9	114.2	100.3	84.0	68.4	48.0
VS 25/13	15	20	157.3	142.3	133.2	123.7	108.6	91.0	74.1	52.0
VS 25/14	15	20	169.4	153.2	143.4	133.2	117.0	98.0	79.8	56.0
VS 25/15	15	20	181.5	164.1	153.6	142.7	125.4	105.0	85.5	60.0
VS 25/16	18.5	25	193.6	175.1	163.9	152.2	133.7	112.0	91.2	64.0
VS 25/17	18.5	25	205.7	186.0	174.1	161.7	142.1	119.0	96.9	68.0
VS 25/18	18.5	25	217.8	197.0	184.4	171.3	150.4	126.0	102.6	72.0
VS 25/19	18.5	25	229.9	207.9	194.6	180.8	158.8	133.0	108.3	76.0
VS 25/20	22	30	242.0	218.9	204.9	190.3	167.1	140.0	114.0	80.0
VS 25/21	22	30	254.1	229.8	215.1	199.8	175.5	147.0	119.7	84.0
VS 25/22	22	30	266.2	240.7	225.3	209.3	183.9	154.0	125.4	88.0
VS 25/23	22	30	278.3	251.7	235.6	218.8	192.2	161.0	131.1	92.0
VS 25/24	30	40	290.4	262.6	245.8	228.3	200.6	168.0	136.8	96.0
VS 25/25	30	40	302.5	273.6	256.1	237.9	208.9	175.0	142.5	100.0
VS 25/26	30	40	314.6	284.5	266.3	247.4	217.3	182.0	148.2	104.0
VS 25/27	30	40	326.7	295.5	276.6	256.9	225.6	189.0	153.9	108.0
VS 25/28	30	40	338.8	306.4	286.8	266.4	234.0	196.0	159.6	112.0
VS 25/29	30	40	350.9	317.3	297.0	275.9	242.4	203.0	165.3	116.0
VS 25/30	30	40	363.0	328.3	307.3	285.4	250.7	210.0	171.0	120.0
VS 25/31	30	40	375.1	339.2	317.5	294.9	259.1	217.0	176.7	124.0
VS 25/32	37	50	387.2	350.2	327.8	304.5	267.4	224.0	182.4	128.0
VS 25/33	37	50	399.3	361.1	338.0	314.0	275.8	231.0	188.1	132.0
VS 25/34	37	50	411.4	372.1	348.3	323.5	284.1	238.0	193.8	136.0
VS 25/35	37	50	423.5	383.0	358.5	333.0	292.5	245.0	199.5	140.0
VS 25/36	37	50	435.6	393.9	368.7	342.5	300.9	252.0	205.2	144.0
VS 25/37	37	50	447.7	404.9	379.0	352.0	309.2	259.0	210.9	148.0
VS 25/38	37	50	459.8	415.8	389.2	361.5	317.6	266.0	216.6	152.0
VS 25/39	45	60	471.9	426.8	399.5	371.1	325.9	273.0	222.3	156.0
VS 25/40	45	60	484.0	437.7	409.7	380.6	334.3	280.0	228.0	160.0
VS 25/41	45	60	496.1	448.7	420.0	390.1	342.6	287.0	233.7	164.0
VS 25/42	45	60	508.2	459.6	430.2	399.6	351.0	294.0	239.4	168.0
VS 25/43	45	60	520.3	470.5	440.4	409.1	359.4	301.0	245.1	172.0
VS 25/44	45	60	532.4	481.5	450.7	418.6	367.7	308.0	250.8	176.0
VS 25/45	45	60	544.5	492.4	460.9	428.1	376.1	315.0	256.5	180.0
VS 25/46	45	60	556.6	503.4	471.2	437.7	384.4	322.0	262.2	184.0

VS 30

Pump model	Vers. R	RATED POWER		Q = DELIVERY						
				m ³ /h 0	15	20	25	30	35	40
		[kW]	[HP]	l/min 0	250	333.5	416.5	500	583.5	666.5
H = TOTAL METERS HEAD OF WATER COLUMN [m]										
VS 30/3	●	3.7	5	46.3	38.9	36	33.3	30.2	26.7	21.7
VS 30/4	●	5.5	7.5	62.5	52.6	48.8	45.2	41.1	36.5	30
VS 30/5	●	7.5	10	78.6	66.2	61.5	56.9	51.8	46.1	38
VS 30/6	●	7.5	10	93.1	78.4	72.6	67.1	61	54	44.1
VS 30/7	●	9.3	12.5	110	92.6	86	79.7	72.6	64.6	53.3
VS 30/8	●	11	15	125.5	105.7	98.1	90.9	82.7	73.6	60.5
VS 30/9	●	11	15	140.1	117.9	109.3	101.1	91.8	81.4	66.6
VS 30/10	●	15	20	158.2	133.3	123.8	114.9	104.7	93.5	77.3
VS 30/11	●	15	20	173	145.7	135.3	125.4	114.1	101.7	83.8
VS 30/12	●	15	20	187.7	158	146.6	135.7	123.4	109.6	90
VS 30/13	●	18.5	25	205.2	172.9	160.6	148.9	135.7	121.1	100
VS 30/14	●	18.5	25	220	185.3	172.1	159.4	145.1	129.2	106.5
VS 30/15	●	22	30	237	199.7	185.5	172.1	156.8	140	115.7
VS 30/16	●	22	30	251.9	212.2	197.1	182.6	166.3	148.3	122.3
VS 30/17	●	22	30	266.7	224.5	208.4	193	175.7	156.4	128.7
VS 30/18	●	22	30	281.3	236.8	219.7	203.3	185	164.3	134.9
VS 30/19	●	30	40	302.1	254.7	236.8	219.9	200.7	179.7	149.2
VS 30/20	●	30	40	317.3	267.4	248.6	230.7	210.5	188.2	156
VS 30/21	●	30	40	332.3	280	260.2	241.5	220.1	196.7	162.8
VS 30/22	●	30	40	347.3	292.6	271.8	252.1	229.7	205	169.4
VS 30/23	●	30	40	362.2	305.1	283.4	262.6	239.2	213.2	175.9
VS 30/24	●	30	40	377	317.5	294.8	273.1	248.6	221.4	182.2
VS 30/25	●	37	50	395.2	333	309.4	287	261.5	233.5	193.1
VS 30/26	●	37	50	410.1	345.5	320.9	297.5	271.1	241.8	199.7
VS 30/27	●	37	50	425	357.9	332.4	308.1	280.5	250	206.1
VS 30/28	●	37	50	439.8	370.3	343.8	318.5	289.9	258.1	212.5
VS 30/29	●	37	50	454.5	382.6	355.2	328.9	299.2	266.2	218.8
VS 30/30	●	37	50	469.1	394.9	366.4	339.1	308.5	274.1	224.9
VS 30/31		45	60	490	412.9	383.6	355.8	324.2	289.4	239.3
VS 30/32		45	60	505	425.4	395.2	366.4	333.7	297.7	245.8
VS 30/33		45	60	519.8	437.9	406.7	376.9	343.2	305.9	252.2
VS 30/34		45	60	534.6	450.3	418.1	387.3	352.6	314	258.6
VS 30/35		45	60	549.4	462.6	429.5	397.7	361.9	322	264.8
VS 30/36		45	60	564.1	474.9	440.8	408	371.1	329.9	270.9
VS 30/37		45	60	578.7	487.1	452	418.2	380.3	337.7	277
VS 30/38		55	75	612.9	517.4	481.6	448.2	409.8	368.6	308.6
VS 30/39		55	75	628.4	530.5	493.7	459.4	420	377.6	315.9
VS 30/40		55	75	644	543.5	505.8	470.6	430.1	386.6	323.2
VS 30/41		55	75	659.4	556.6	517.9	481.7	440.2	395.6	330.5
VS 30/42		55	75	674.9	569.5	529.9	492.8	450.3	404.5	337.7
VS 30/43		55	75	690.3	582.5	542	503.9	460.3	413.3	344.9

● = Pump available in R version (AISI 904L)



VS 46

Pump model	Vers. R	RATED POWER		Q = DELIVERY							
				m ³ /h 0	25	30	35	40	45	50	55
		[kW]	[HP]	l/min 0	416.5	500	583.5	666.5	750	833.5	916.5
				H = TOTAL METERS HEAD OF WATER COLUMN [m]							
VS 46/2	●	3	4	26.4	22.6	20.9	19.3	17.8	16.6	15.1	13.4
VS 46/3	●	4	5.5	39.4	33.8	31.2	28.8	26.6	24.7	22.5	19.9
VS 46/4	●	5.5	7.5	52.5	45	41.5	38.3	35.5	32.9	29.9	26.5
VS 46/5	●	7.5	10	66.1	56.8	52.3	48.3	44.7	41.5	37.8	33.6
VS 46/6	●	9.3	12.5	80.7	70	65.2	60.4	55.5	50.3	46	41.6
VS 46/7	●	9.3	12.5	93.1	80.4	74.8	69.3	63.5	57.6	52.7	47.5
VS 46/8	●	11	15	106.1	91.6	85.1	78.9	72.2	65.5	59.9	54
VS 46/9	●	15	20	121.5	105.5	98.2	91	83.7	75.9	69.5	62.9
VS 46/10	●	15	20	134	116.1	108	100.1	91.9	83.3	76.2	68.9
VS 46/11	●	15	20	146.3	126.5	117.6	109	99.9	90.5	82.8	74.7
VS 46/12	●	18.5	25	161.3	140	130.3	120.8	110.9	100.6	92	83.3
VS 46/13	●	18.5	25	173.8	150.5	140	129.8	119	107.9	98.7	89.2
VS 46/14	●	18.5	25	186.1	160.9	149.5	138.7	127	115.1	105.3	95
VS 46/15	●	22	30	200.8	174.1	161.9	150.1	137.7	124.9	114.3	103.3
VS 46/16	●	22	30	213.2	184.5	171.5	159.1	145.8	132.2	120.9	109.1
VS 46/17	●	22	30	225.4	194.7	181	167.8	153.6	139.3	127.3	114.8
VS 46/18	●	30	40	243.8	212.3	197.6	183.1	168.6	152.9	139.9	126.8
VS 46/19	●	30	40	256.6	223.1	207.7	192.5	177	160.5	146.9	133
VS 46/20	●	30	40	269.2	233.8	217.6	201.7	185.3	168.1	153.7	139.1
VS 46/21	●	30	40	281.8	244.4	227.4	210.8	193.5	175.5	160.5	145.2
VS 46/22	●	30	40	294.2	254.9	237	219.8	201.6	182.8	167.2	151.1
VS 46/23	●	30	40	306.6	265.2	246.6	228.6	209.5	190	173.8	156.9
VS 46/24	●	37	50	322.4	279.8	260.3	241.3	221.6	200.9	183.8	166.3
VS 46/25	●	37	50	334.9	290.3	270	250.3	229.7	208.3	190.6	172.2
VS 46/26		37	50	347.3	300.7	279.6	259.3	237.8	215.6	197.2	178.1
VS 46/27		37	50	359.6	311.1	289.2	268.2	245.7	222.8	203.7	183.9
VS 46/28		37	50	371.8	321.3	298.6	276.9	253.6	229.9	210.2	189.6
VS 46/29		45	60	390.1	338.7	315.1	292.1	268.3	243.3	222.6	201.4
VS 46/30		45	60	402.7	349.2	324.9	301.1	276.5	250.7	229.4	207.4
VS 46/31		45	60	415.1	359.6	334.5	310.1	284.5	258	236	213.3
VS 46/32		45	60	427.5	370	344.1	319	292.5	265.2	242.6	219.1
VS 46/33		45	60	439.8	380.3	353.5	327.8	300.4	272.3	249.1	224.8
VS 46/34		55	75	469.3	410.9	383.1	354.8	328	297.6	271.9	248.1
VS 46/35		55	75	482.5	422.3	393.7	364.6	337	305.8	279.4	254.8
VS 46/36		55	75	495.7	433.7	404.3	374.4	345.9	313.9	286.8	261.4
VS 46/37		55	75	508.9	445	414.8	384.1	354.8	321.9	294.2	268.1
VS 46/38		55	75	522	456.3	425.3	393.8	363.7	330	301.6	274.7
VS 46/39		55	75	535.1	467.5	435.7	403.5	372.5	337.9	308.9	281.2
VS 46/40		55	75	548.1	478.7	446.1	413.1	381.3	345.9	316.2	287.8

● = Pump available in R version (AISI 904L)

VS 65

Pump model	Vers. R	RATED POWER		Q = DELIVERY								
				m ³ /h 0	40	45	50	55	60	65	70	75
		[kW]	[HP]	l/min 0	666.5	750	833.5	916.5	1000	1083.5	1166.5	1250
H = TOTAL METERS HEAD OF WATER COLUMN [m]												
VS 65/2	●	3.7	5	26.8	19	17.3	16.5	15.7	14.9	13.9	12.4	10.5
VS 65/3	●	5.5	7.5	40.4	28.8	26.2	24.9	23.7	22.5	21	18.9	16
VS 65/4	●	7.5	10	54	38.4	35	33.2	31.6	30.1	28	25.2	21.4
VS 65/5	●	9.3	12.5	68	48.7	44.3	41.9	40.1	38.2	35.6	32.2	27.5
VS 65/6	●	11	15	81.2	57.9	52.7	50	47.7	45.3	42.3	38.1	32.3
VS 65/7	●	15	20	94.9	70.1	65.2	61.7	58.6	55.7	52.1	46.1	39.7
VS 65/8	●	15	20	107.6	79.1	73.5	69.7	66.1	62.8	58.5	51.6	44.3
VS 65/9	●	15	20	120.1	87.8	81.5	77.4	73.4	69.6	64.6	56.8	48.6
VS 65/10	●	18.5	25	134.5	99	91.9	87.2	82.7	78.5	73.2	64.6	55.5
VS 65/11	●	18.5	25	147	107.8	100.1	95	90	85.4	79.4	69.8	59.9
VS 65/12	●	22	30	161.2	118.5	110.1	104.4	99.1	94.1	87.6	77.3	66.3
VS 65/13	●	22	30	173.7	127.3	118.2	112.2	106.4	101	93.8	82.5	70.8
VS 65/14	●	30	40	190.3	141	131.1	124	118	112	104.9	93	80.2
VS 65/15	●	30	40	203.2	150.2	139.6	132.2	125.7	119.3	111.5	98.7	85
VS 65/16	●	30	40	216	159.3	148	140.3	133.2	126.5	118.1	104.3	89.7
VS 65/17	●	30	40	228.6	168.3	156.3	148.2	140.7	133.5	124.4	109.8	94.3
VS 65/18	●	37	50	243.4	179.8	167	158.2	150.3	142.7	133.3	117.9	101.5
VS 65/19	●	37	50	256.1	188.8	175.4	166.2	157.9	149.9	139.8	123.5	106.1
VS 65/20	●	37	50	268.8	197.7	183.7	174.1	165.3	156.9	146.2	128.9	110.7
VS 65/21	●	37	50	281.4	206.5	191.8	182	172.6	163.8	152.4	134.2	115.1
VS 65/22		45	60	297.7	219.9	204.4	193.6	183.9	174.6	163.2	144.3	124.2
VS 65/23		45	60	310.5	229	212.7	201.6	191.4	181.7	169.6	149.8	128.9
VS 65/24		45	60	323.2	237.9	221	209.5	198.9	188.8	176	155.3	133.4
VS 65/25		45	60	335.8	246.7	229.2	217.3	206.2	195.7	182.2	160.6	137.9
VS 65/26		45	60	348.4	255.5	237.3	225.1	213.5	202.5	188.3	165.8	142.2
VS 65/27		55	75	372.8	278.8	259.3	244.7	233.4	221.6	208.5	186.4	161.6
VS 65/28		55	75	386.1	288.5	268.3	253.3	241.5	229.3	215.7	192.6	166.9
VS 65/29		55	75	399.4	298.1	277.2	261.8	249.5	237	222.8	198.8	172.2
VS 65/30		55	75	412.6	307.7	286.1	270.3	257.6	244.6	229.8	204.9	177.4
VS 65/31		55	75	425.8	317.3	295	278.7	265.5	252.2	236.8	211	182.6

● = Pump available in R version (ANSI 904L)

VS 14 - TECHNICAL DATA

PUMPS WITH ENCAPSULATED MOTOR

Pump model	Motor			Dimensions					Pump weight [Kg]
	Type	[kW]	[HP]	L1 [mm]	L2 [mm]	Lt [mm]	D [mm]		
							1 cable	2 cable	
VS 14/5	E4 *	2.2	3	413.5	422	835.5	142.5	-	26.5
VS 14/6		3.7	5	443.5	520	963.5	142.5	-	32
VS 14/7		3.7	5	473.5	520	993.5	142.5	-	32
VS 14/8		3.7	5	503.5	520	1023.5	142.5	-	33
VS 14/9		5.5	7.5	533.5	652.5	1186	142.5	-	41
VS 14/10		5.5	7.5	563.5	652.5	1216	142.5	-	41.5
VS 14/11		5.5	7.5	593.5	652.5	1246	142.5	-	42.5
VS 14/12		5.5	7.5	623.5	652.5	1276	142.5	-	43.5
VS 14/13		5.5	7.5	653.5	652.5	1306	142.5	-	44
VS 14/14		7.5	10	683.5	730.5	1414	142.5	-	49
VS 14/15		7.5	10	713.5	730.5	1444	142.5	-	49.5
VS 14/16		7.5	10	743.5	730.5	1474	142.5	-	50.5
VS 14/17		7.5	10	773.5	730.5	1504	142.5	-	51

* Kit 1425I005 necessary for 4" motors

VS 14/5	E6	4	5.5	411	581	992	143	144.5	49
VS 14/6		4	5.5	441	581	1022	143	144.5	50
VS 14/7		4	5.5	471	581	1052	143	144.5	50.5
VS 14/8		4	5.5	501	581	1082	143	144.5	51.5
VS 14/9		5.5	7.5	531	614.5	1145.5	143	144.5	55.5
VS 14/10		5.5	7.5	561	614.5	1175.5	143	144.5	56
VS 14/11		5.5	7.5	591	614.5	1205.5	143	144.5	57
VS 14/12		5.5	7.5	621	614.5	1235.5	143	144.5	58
VS 14/13		5.5	7.5	651	614.5	1265.5	143	144.5	58.5
VS 14/14		7.5	10	681	646	1327	143	144.5	63.5
VS 14/15		7.5	10	711	646	1357	143	144.5	64
VS 14/16		7.5	10	741	646	1387	143	144.5	65
VS 14/17		7.5	10	771	646	1417	143	144.5	65.5
VS 14/18		9.3	12.5	801	678.5	1479.5	143	144.5	69
VS 14/19		9.3	12.5	831	678.5	1509.5	143	144.5	69.5
VS 14/20		9.3	12.5	861	678.5	1539.5	143	144.5	70.5
VS 14/21		9.3	12.5	891	678.5	1569.5	143	144.5	71
VS 14/22		9.3	12.5	921	678.5	1599.5	143	144.5	71.5
VS 14/23		11	15	951	711	1662	143	144.5	76
VS 14/24		11	15	981	711	1692	143	144.5	76.5
VS 14/25		11	15	1011	711	1722	143	144.5	77.5
VS 14/26		11	15	1041	711	1752	143	144.5	78

PUMPS WITH REWINDABLE MOTOR

Pump model	Motor			Dimensions					Pump weight [Kg]
	Type	[kW]	[HP]	L1 [mm]	L2 [mm]	Lt [mm]	D [mm]		
							1 cable	2 cable	
VS 14/5	RW6	4	5.5	411	699	1110	147	147.5	59.5
VS 14/6		4	5.5	441	699	1140	147	147.5	60.5
VS 14/7		4	5.5	471	699	1170	147	147.5	61
VS 14/8		4	5.5	501	699	1200	147	147.5	62
VS 14/9		5.5	7.5	531	699	1230	147	147.5	62.5
VS 14/10		5.5	7.5	561	699	1260	147	147.5	63
VS 14/11		5.5	7.5	591	699	1290	147	147.5	64
VS 14/12		5.5	7.5	621	699	1320	147	147.5	65
VS 14/13		5.5	7.5	651	699	1350	147	147.5	65.5
VS 14/14		7.5	10	681	719	1400	147	147.5	68.5
VS 14/15		7.5	10	711	719	1430	147	147.5	69
VS 14/16		7.5	10	741	719	1460	147	147.5	70
VS 14/17		7.5	10	771	719	1490	147	147.5	70.5
VS 14/18		9.3	12.5	801	749	1550	147	147.5	74.5
VS 14/19		9.3	12.5	831	749	1580	147	147.5	75
VS 14/20		9.3	12.5	861	749	1610	147	147.5	76
VS 14/21		9.3	12.5	891	749	1640	147	147.5	76.5
VS 14/22		9.3	12.5	921	749	1670	147	147.5	77
VS 14/23		11	15	951	699	1650	147	147.5	81
VS 14/24		11	15	981	719	1700	147	147.5	81.5
VS 14/25		11	15	1011	749	1760	147	147.5	82.5
VS 14/26		11	15	1041	779	1820	147	147.5	83

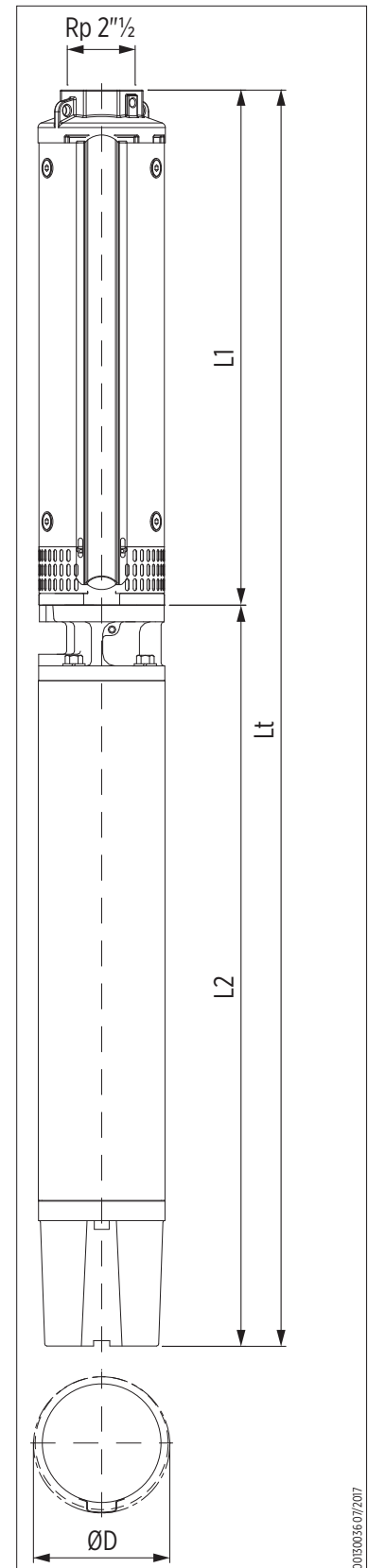

0030036/07/207

VS 14 - PERFORMANCE CURVES AT 50 HZ

MEI ≥ 0,40

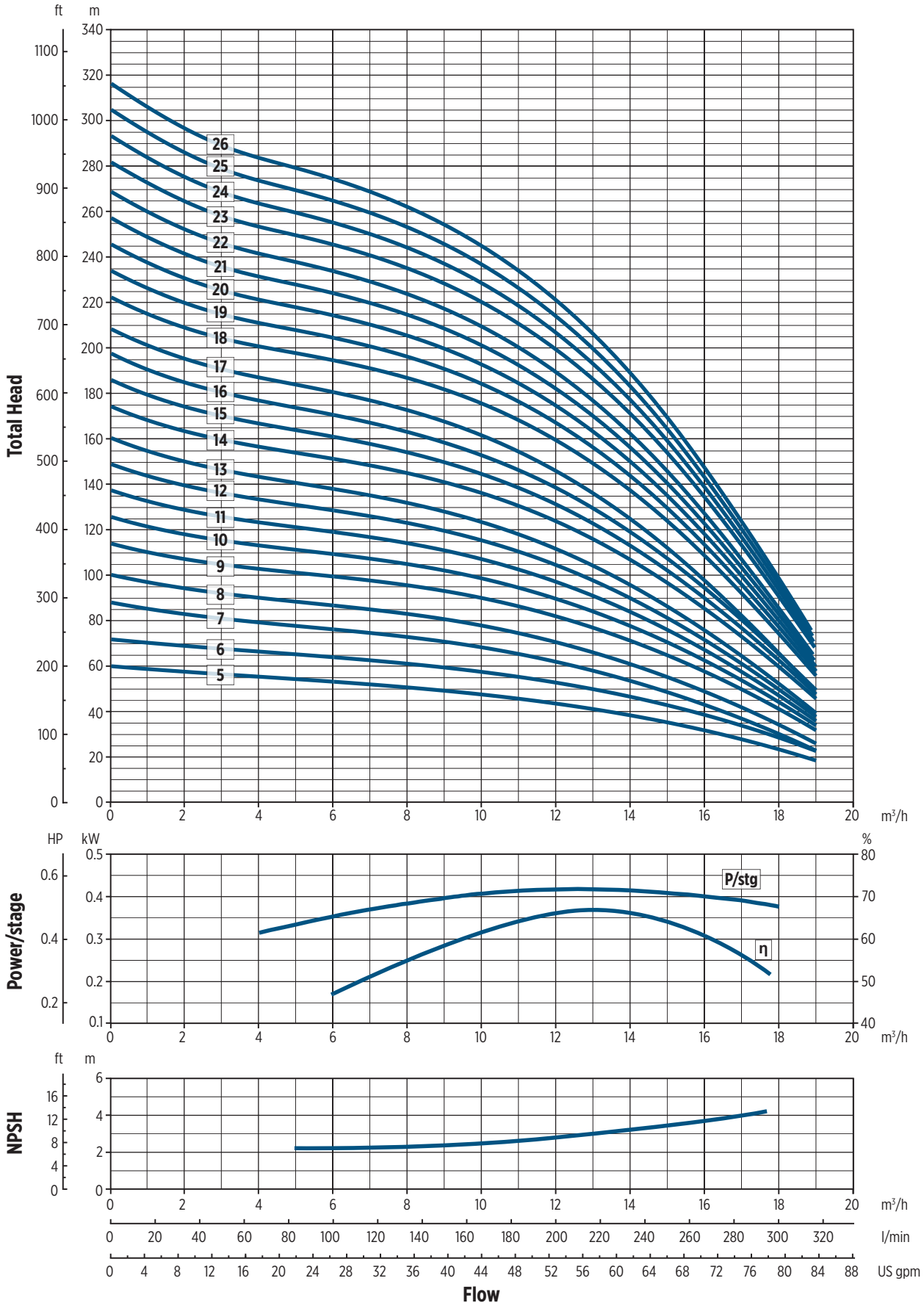

00206REV 01/2017

The hydraulic characteristics are guaranteed, according to ISO standard 9906:2012, grade 3B

VS 14 - TECHNICAL DATA

PUMPS WITH ENCAPSULATED MOTOR

Pump model	Motor			Dimensions					Pump weight [Kg]
	Type	[kW]	[HP]	L1 [mm]	L2 [mm]	Lt [mm]	D [mm]		
							1 cable	2 cable	
VS 14/27	E6	15	20	1071	776	1847	143	144.5	85.5
VS 14/28		15	20	1101	776	1877	143	144.5	85.5
VS 14/29		15	20	1131	776	1907	143	144.5	87
VS 14/30		15	20	1161	776	1937	143	144.5	87.5
VS 14/31		15	20	1191	776	1967	143	144.5	87.5
VS 14/32		15	20	1220.5	776	1996.5	143	144.5	88
VS 14/33		15	20	1250.5	776	2026.5	143	144.5	89
VS 14/34		15	20	1280.5	776	2056.5	143	144.5	90
VS 14/35		15	20	1310.5	776	2086.5	143	144.5	90.5
VS 14/36		15	20	1340.5	776	2116.5	143	144.5	91
VS 14/37		18.5	25	1370.5	841.5	2212	143	144.5	99
VS 14/38		18.5	25	1400.5	841.5	2242	143	144.5	99.5
VS 14/39		18.5	25	1430.5	841.5	2272	143	144.5	101
VS 14/40		18.5	25	1460.5	841.5	2302	143	144.5	102
VS 14/41		18.5	25	1490.5	841.5	2332	143	144.5	102.5
VS 14/42		18.5	25	1520.5	841.5	2362	143	144.5	102.5
VS 14/43		18.5	25	1550.5	841.5	2392	143	144.5	103.5
VS 14/44		18.5	25	1580.5	841.5	2422	143	144.5	104
VS 14/45		22	30	1610.5	906.5	2517	143	144.5	111
VS 14/46		22	30	1640.5	906.5	2547	143	144.5	111.5
VS 14/47		22	30	1670.5	906.5	2577	143	144.5	112.5
VS 14/48		22	30	1700	906.5	2606.5	143	144.5	113.5
VS 14/49	22	30	1730.5	906.5	2637	143	144.5	114.5	

PUMPS WITH REWINDABLE MOTOR

Pump model	Motor			Dimensions					Pump weight [Kg]
	Type	[kW]	[HP]	L1 [mm]	L2 [mm]	Lt [mm]	D [mm]		
							1 cable	2 cable	
VS 14/27	RW6	13	17.5	1071	829	1900	147	147.5	90
VS 14/28		13	17.5	1101	829	1930	147	147.5	90
VS 14/29		13	17.5	1131	829	1960	147	147.5	91.5
VS 14/30		13	17.5	1161	829	1990	147	147.5	92
VS 14/31		13	17.5	1191	829	2020	147	147.5	92
VS 14/32		15	20	1220.5	874	2094.5	147	147.5	97.5
VS 14/33		15	20	1250.5	874	2124.5	147	147.5	98.5
VS 14/34		15	20	1280.5	874	2154.5	147	147.5	99.5
VS 14/35		15	20	1310.5	874	2184.5	147	147.5	100
VS 14/36		15	20	1340.5	874	2214.5	147	147.5	100.5
VS 14/37		18.5	25	1370.5	919	2289.5	147	147.5	105.5
VS 14/38		18.5	25	1400.5	919	2319.5	147	147.5	106
VS 14/39		18.5	25	1430.5	919	2349.5	147	147.5	107.5
VS 14/40		18.5	25	1460.5	919	2379.5	147	147.5	108.5
VS 14/41		18.5	25	1490.5	919	2409.5	147	147.5	109
VS 14/42		18.5	25	1520.5	919	2439.5	147	147.5	109
VS 14/43		18.5	25	1550.5	919	2469.5	147	147.5	110
VS 14/44		18.5	25	1580.5	919	2499.5	147	147.5	110.5
VS 14/45		22	30	1610.5	1009	2619.5	147	147.5	120.5
VS 14/46		22	30	1640.5	1009	2649.5	147	147.5	121
VS 14/47		22	30	1670.5	1009	2679.5	147	147.5	122
VS 14/48		22	30	1700	1009	2709	147	147.5	123
VS 14/49	22	30	1730.5	1009	2739.5	147	147.5	124	

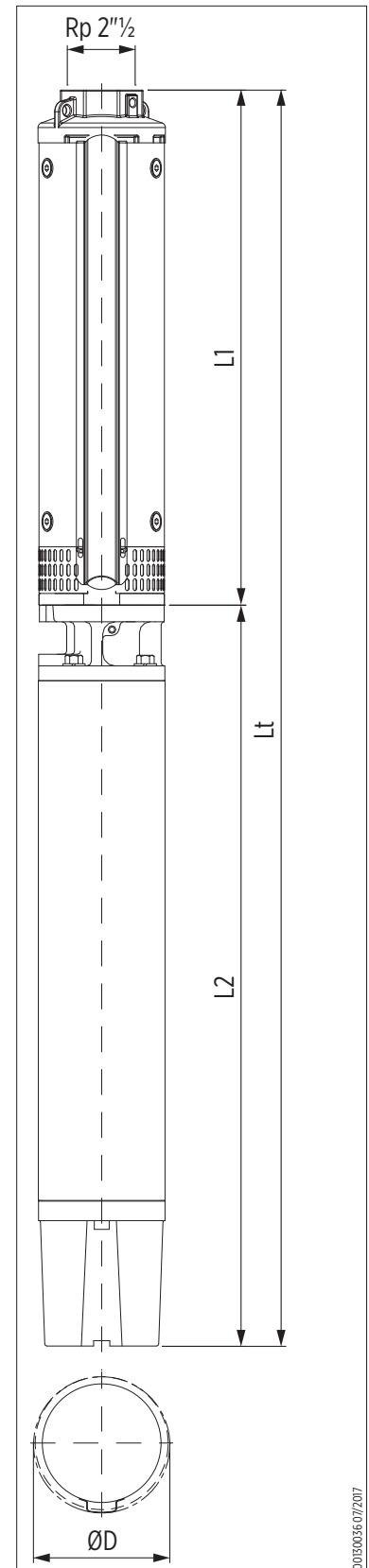

0030036/07207

VS 14 - PERFORMANCE CURVES AT 50 HZ

MEI ≥ 0,40

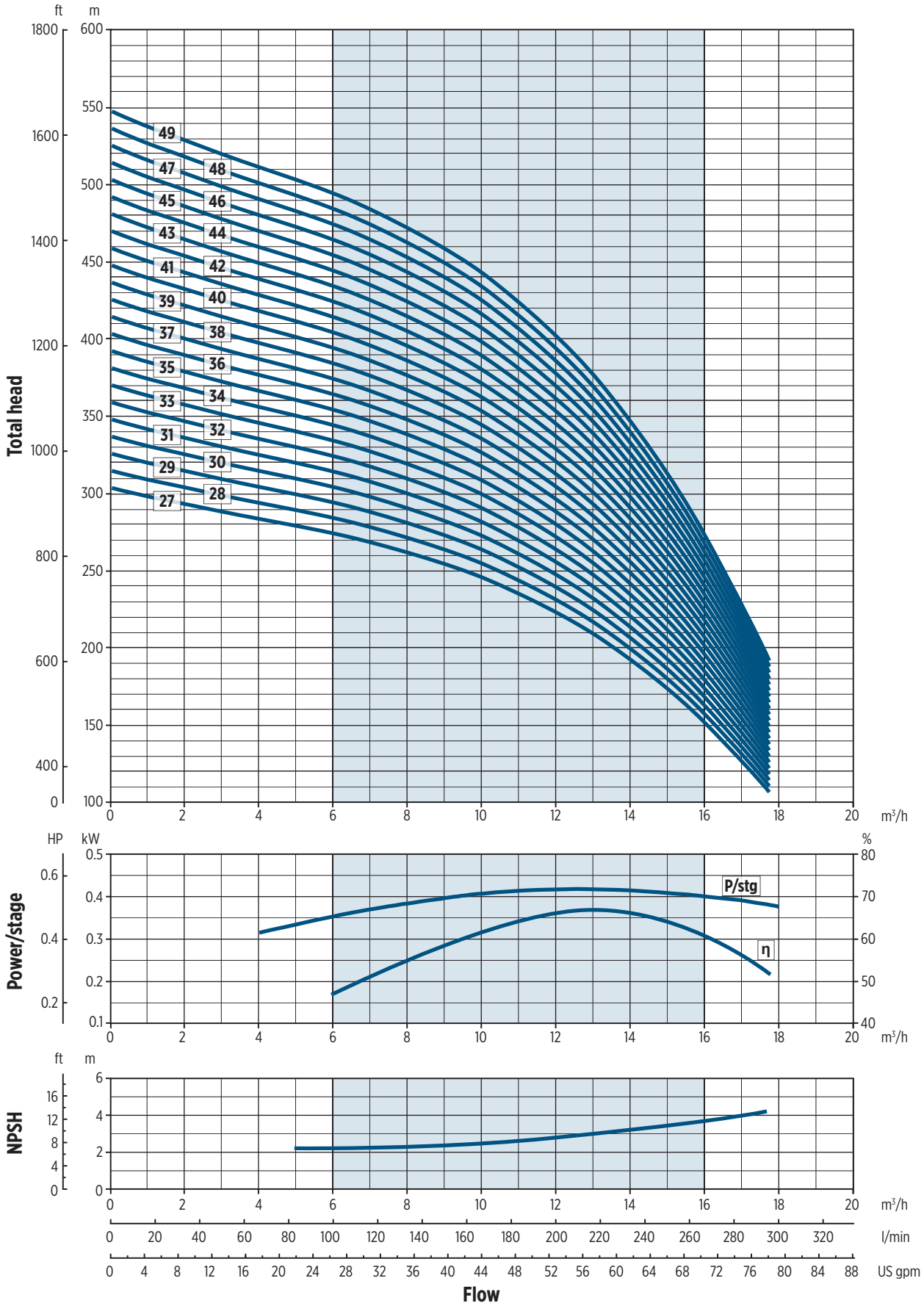

The hydraulic characteristics are guaranteed, according to ISO standard 9906:2012, grade 3B

VS 14 HIGH PRESSURE - TECHNICAL DATA

PUMPS WITH ENCAPSULATED MOTOR

Pump model	Motor			Dimensions					Pump weight [Kg]
	Type	[kW]	[HP]	L1 [mm]	L2 [mm]	Lt [mm]	D [mm]		
							1 cable	2 cable	
VS 14/50	E6	22	30	1760.5	906.5	2667	145	146.5	115.5
VS 14/51		22	30	1790.5	906.5	2697	145	146.5	116.5
VS 14/52		22	30	1820.5	906.5	2727	145	146.5	117.5
VS 14/53		30	40	1850.5	1036.5	2887	145	146.5	133
VS 14/54		30	40	1880.5	1036.5	2917	145	146.5	133.5
VS 14/55		30	40	1910.5	1036.5	2947	145	146.5	134.5
VS 14/56		30	40	1940.5	1036.5	2977	145	146.5	135.5
VS 14/57		30	40	1970.5	1036.5	3007	145	146.5	136
VS 14/58		30	40	2000	1036.5	3036.5	145	146.5	137
VS 14/59		30	40	2030	1036.5	3066.5	145	146.5	138
VS 14/60		30	40	2060	1036.5	3096.5	145	146.5	139
VS 14/61		30	40	2090	1036.5	3126.5	145	146.5	140

PUMPS WITH REWINDABLE MOTOR

Pump model	Motor			Dimensions					Pump weight [Kg]
	Type	[kW]	[HP]	L1 [mm]	L2 [mm]	Lt [mm]	D [mm]		
							1 cable	2 cable	
VS 14/50	RW6	22	30	1760.5	1009	2769.5	149	149.5	125
VS 14/51		22	30	1790.5	1009	2799.5	149	149.5	126
VS 14/52		22	30	1820.5	1009	2829.5	149	149.5	127
VS 14/53		26	35	1850.5	1114	2964.5	149	149.5	139
VS 14/54		26	35	1880.5	1114	2994.5	149	149.5	139.5
VS 14/55		26	35	1910.5	1114	3024.5	149	149.5	140.5
VS 14/56		26	35	1940.5	1114	3054.5	149	149.5	141.5
VS 14/57		26	35	1970.5	1114	3084.5	149	149.5	142
VS 14/58		26	35	2000	1114	3114	149	149.5	143
VS 14/59		26	35	2030	1114	3144	149	149.5	144
VS 14/60		26	35	2060	1114	3174	149	149.5	145
VS 14/61		26	35	2090	1114	3204	149	149.5	146

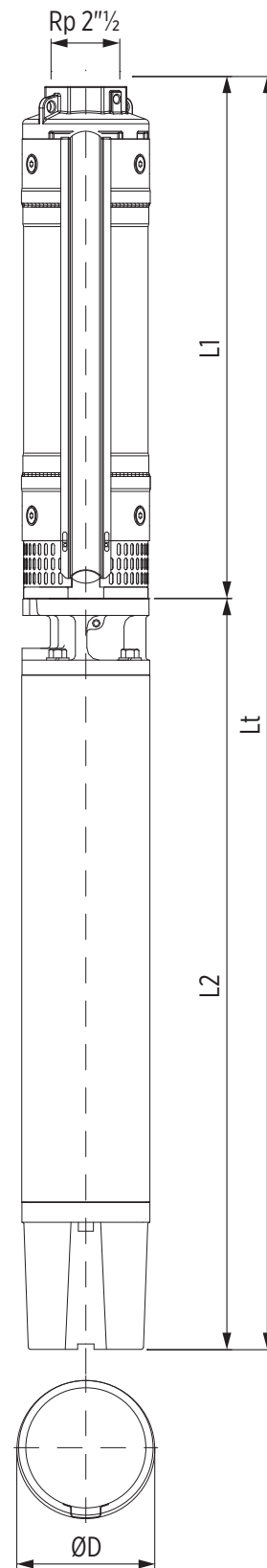

0030057 07/2017

VS 14 HIGH PRESSURE - PERFORMANCE CURVES AT 50 HZ

MEI ≥ 0,40

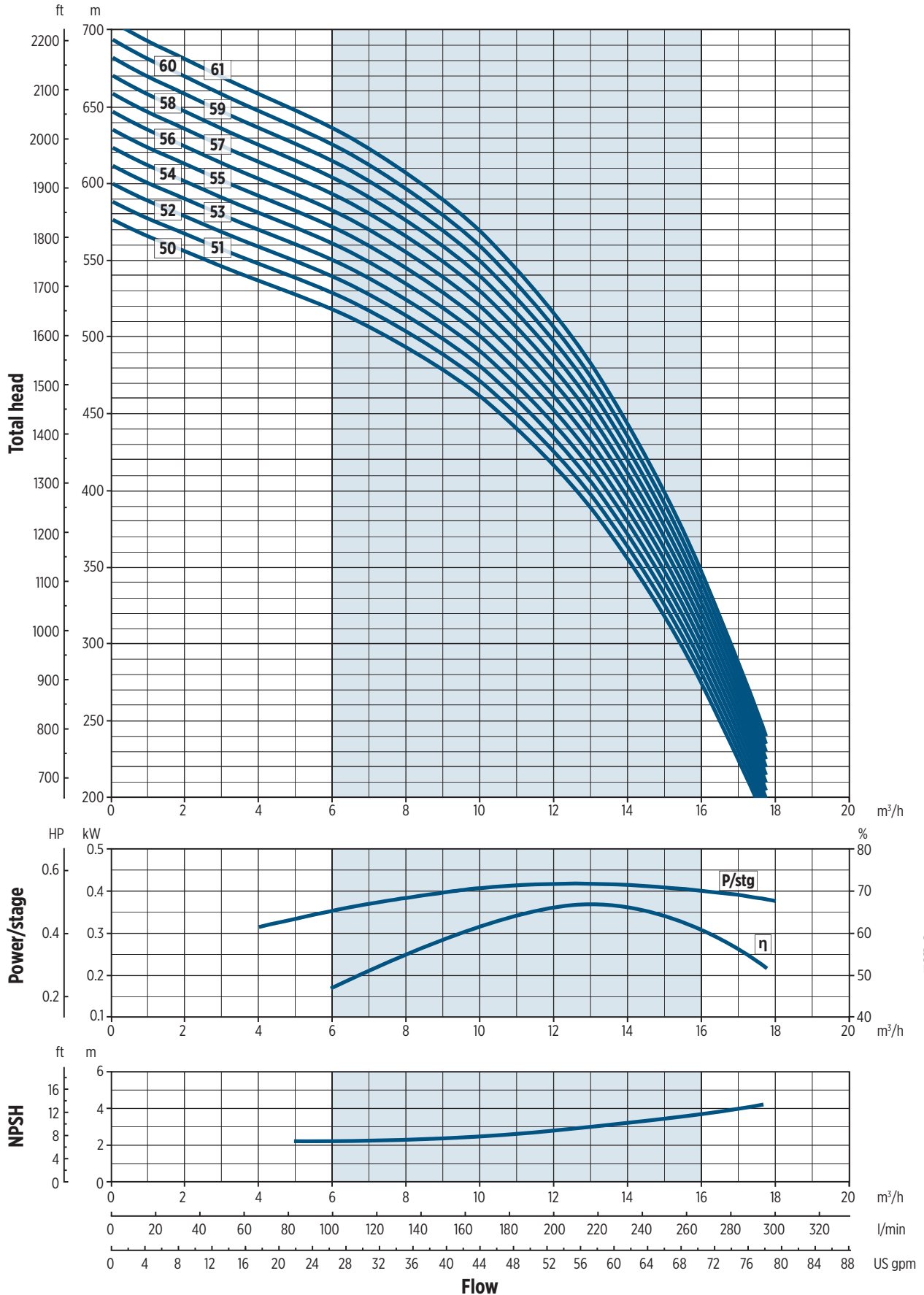

The hydraulic characteristics are guaranteed, according to ISO standard 9906:2012, grade 3B

VS 19 - TECHNICAL DATA

PUMPS WITH ENCAPSULATED MOTOR

Pump model	Motor			Dimensions					Pump weight [Kg]
	Type	[kW]	[HP]	L1 [mm]	L2 [mm]	Lt [mm]	D [mm]		
							1 cable	2 cable	
VS 19/6	E4 *	3.7	5	497.5	520	1017.5	142.5	-	31.5
VS 19/7		5.5	7.5	535	652.5	1187.5	142.5	-	40
VS 19/8		5.5	7.5	572.5	652.5	1225	142.5	-	41
VS 19/9		5.5	7.5	610	652.5	1262.5	142.5	-	41.5
VS 19/10		7.5	10	647.5	730.5	1378	142.5	-	46.5
VS 19/11		7.5	10	685	730.5	1415.5	142.5	-	47.5
VS 19/12		7.5	10	722.5	730.5	1453	142.5	-	48

* Kit 14251005 necessary for 4" motors

VS 19/6	E6	4	5.5	495	581	1076	143	144.5	50
VS 19/7		5.5	7.5	532.5	614.5	1147	143	144.5	54.5
VS 19/8		5.5	7.5	570	614.5	1184.5	143	144.5	55.5
VS 19/9		5.5	7.5	607.5	614.5	1222	143	144.5	56
VS 19/10		7.5	10	645	646	1291	143	144.5	61
VS 19/11		7.5	10	682.5	646	1328.5	143	144.5	62
VS 19/12		7.5	10	720	646	1366	143	144.5	62.5
VS 19/13		9.3	12.5	757.5	678.5	1436	143	144.5	66
VS 19/14		9.3	12.5	795	678.5	1473.5	143	144.5	67
VS 19/15		9.3	12.5	832.5	678.5	1511	143	144.5	67.5
VS 19/16		11	15	870	711	1581	143	144.5	72
VS 19/17		11	15	907.5	711	1618.5	143	144.5	73
VS 19/18		11	15	945	711	1656	143	144.5	73.5
VS 19/19		15	20	982.5	776	1758.5	143	144.5	80
VS 19/20		15	20	1020	776	1796	143	144.5	80.5
VS 19/21		15	20	1057.5	776	1833.5	143	144.5	81.5
VS 19/22		15	20	1095	776	1871	143	144.5	82.5
VS 19/23		15	20	1132.5	776	1908.5	143	144.5	83
VS 19/24		15	20	1170	776	1946	143	144.5	84

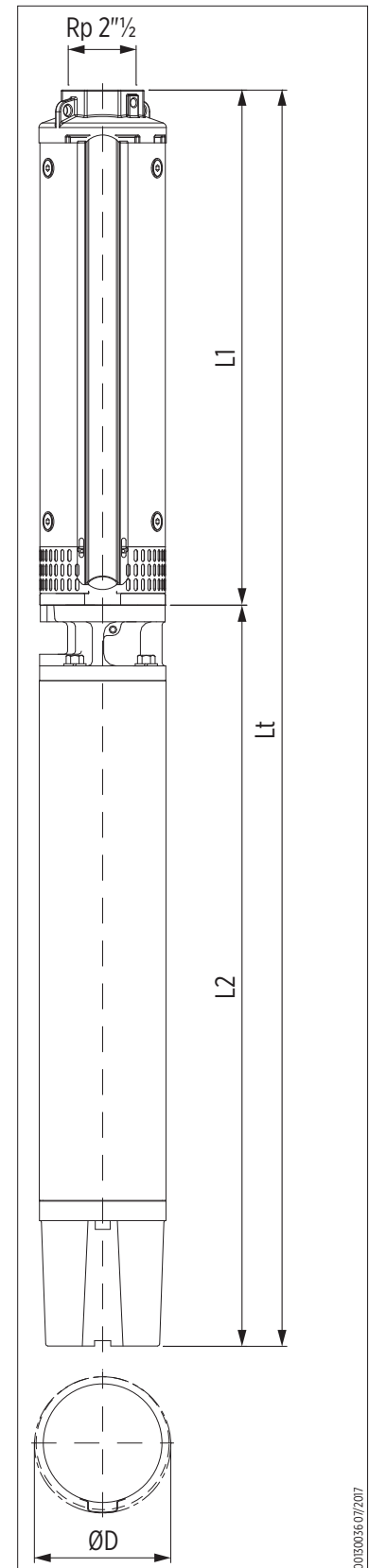

PUMPS WITH REWINDABLE MOTOR

Pump model	Motor			Dimensions					Pump weight [Kg]
	Type	[kW]	[HP]	L1 [mm]	L2 [mm]	Lt [mm]	D [mm]		
							1 cable	2 cable	
VS 19/6	RW6	4	5.5	495	699	1194	147	147.5	60.5
VS 19/7		5.5	7.5	532.5	699	1231.5	147	147.5	61.5
VS 19/8		5.5	7.5	570	699	1269	147	147.5	62.5
VS 19/9		5.5	7.5	607.5	699	1306.5	147	147.5	63
VS 19/10		7.5	10	645	719	1364	147	147.5	66
VS 19/11		7.5	10	682.5	719	1401.5	147	147.5	67
VS 19/12		7.5	10	720	719	1439	147	147.5	67.5
VS 19/13		9.3	12.5	757.5	749	1506.5	147	147.5	71.5
VS 19/14		9.3	12.5	795	749	1544	147	147.5	72.5
VS 19/15		9.3	12.5	832.5	749	1581.5	147	147.5	73
VS 19/16		11	15	870	779	1649	147	147.5	77
VS 19/17		11	15	907.5	779	1686.5	147	147.5	78
VS 19/18		11	15	945	779	1724	147	147.5	78.5
VS 19/19		13	17.5	982.5	829	1811.5	147	147.5	84.5
VS 19/20		13	17.5	1020	829	1849	147	147.5	85
VS 19/21		13	17.5	1057.5	829	1886.5	147	147.5	86
VS 19/22		15	20	1095	874	1969	147	147.5	92
VS 19/23		15	20	1132.5	874	2006.5	147	147.5	92.5
VS 19/24		15	20	1170	874	2044	147	147.5	93.5

VS 19 - PERFORMANCE CURVES AT 50 HZ

MEI ≥ 0,40

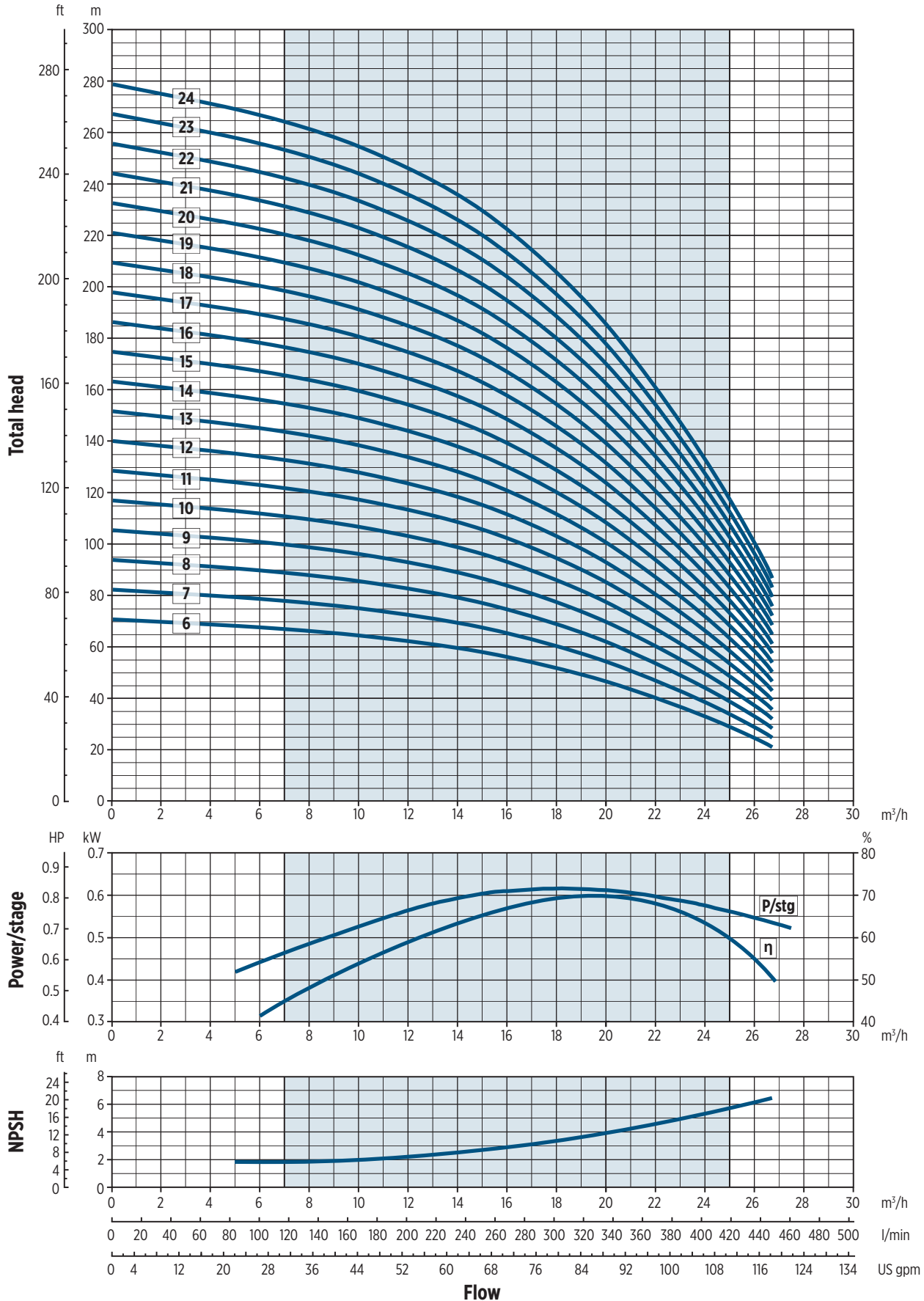

The hydraulic characteristics are guaranteed, according to ISO standard 9906:2012, grade 3B

VS 19 - TECHNICAL DATA

PUMPS WITH ENCAPSULATED MOTOR

Pump model	Motor			Dimensions					Pump weight [Kg]
	Type	[kW]	[HP]	L1 [mm]	L2 [mm]	Lt [mm]	D [mm]		
							1 cable	2 cable	
VS 19/25	E6	18.5	25	1207.5	841.5	2049	143	144.5	92
VS 19/26		18.5	25	1245	841.5	2086.5	143	144.5	92.5
VS 19/27		18.5	25	1282.5	841.5	2124	143	144.5	94.5
VS 19/28		18.5	25	1319.5	841.5	2161	143	144.5	94.5
VS 19/29		18.5	25	1357	841.5	2198.5	143	144.5	95
VS 19/30		18.5	25	1394.5	841.5	2236	143	144.5	96
VS 19/31		22	30	1432	906.5	2338.5	143	144.5	103
VS 19/32		22	30	1469.5	906.5	2376	143	144.5	103.5
VS 19/33		22	30	1507	906.5	2413.5	143	144.5	104.5
VS 19/34		22	30	1544.5	906.5	2451	143	144.5	105
VS 19/35		22	30	1582	906.5	2488.5	143	144.5	106
VS 19/36		22	30	1619.5	906.5	2526	143	144.5	106.5
VS 19/37		30	40	1657	1036.5	2633.5	143	144.5	122.5
VS 19/38		30	40	1694.5	1036.5	2731	143	144.5	124
VS 19/39		30	40	1732	1036.5	2768.5	143	144.5	124
VS 19/40		30	40	1769.5	1036.5	2806	143	144.5	124.5
VS 19/41		30	40	1807	1036.5	2843.5	143	144.5	126
VS 19/42		30	40	1844.5	1036.5	2881	143	144.5	127
VS 19/43		30	40	1882	1036.5	2918.5	143	144.5	128
VS 19/44		30	40	1919.5	1036.5	2956	143	144.5	129
VS 19/45		30	40	1957	1036.5	2993.5	143	144.5	130
VS 19/46		30	40	1994	1036.5	3030.5	143	144.5	131

PUMPS WITH REWINDABLE MOTOR

Pump model	Motor			Dimensions					Pump weight [Kg]
	Type	[kW]	[HP]	L1 [mm]	L2 [mm]	Lt [mm]	D [mm]		
							1 cable	2 cable	
VS 19/25	RW6	18.5	25	1207.5	919	2126.5	147	147.5	98.5
VS 19/26		18.5	25	1245	919	2164	147	147.5	99
VS 19/27		18.5	25	1282.5	919	2201.5	147	147.5	101
VS 19/28		18.5	25	1319.5	919	2238.5	147	147.5	101
VS 19/29		18.5	25	1357	919	2276	147	147.5	101.5
VS 19/30		18.5	25	1394.5	919	2313.5	147	147.5	102.5
VS 19/31		22	30	1432	1009	2441	147	147.5	112.5
VS 19/32		22	30	1469.5	1009	2478.5	147	147.5	113
VS 19/33		22	30	1507	1009	2516	147	147.5	114
VS 19/34		22	30	1544.5	1009	2553.5	147	147.5	114.5
VS 19/35		22	30	1582	1009	2591	147	147.5	115.5
VS 19/36		22	30	1619.5	1009	2628.5	147	147.5	116
VS 19/37		26	35	1657	1114	2771	147	147.5	128.5
VS 19/38		26	35	1694.5	1114	2808.5	147	147.5	130
VS 19/39		26	35	1732	1114	2846	147	147.5	130
VS 19/40		26	35	1769.5	1114	2883.5	147	147.5	130.5
VS 19/41		26	35	1807	1114	2921	147	147.5	132
VS 19/42		26	35	1844.5	1114	2958.5	147	147.5	133
VS 19/43		30	40	1882	1214	3096	147	147.5	144
VS 19/44		30	40	1919.5	1214	3133.5	147	147.5	145
VS 19/45		30	40	1957	1214	3171	147	147.5	146
VS 19/46		30	40	1994	1214	3208	147	147.5	147

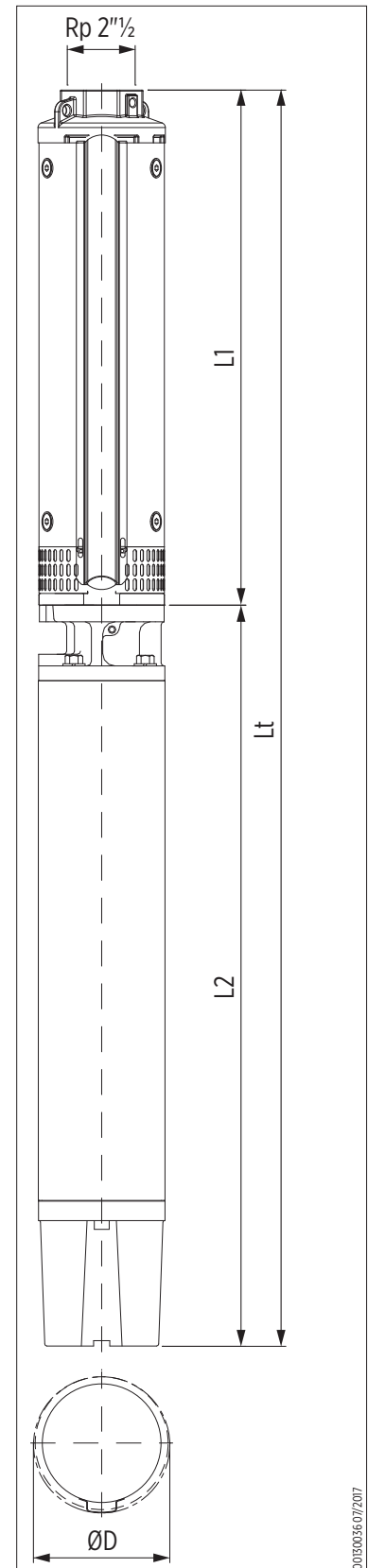

0030036 017/07

VS 19 - PERFORMANCE CURVES AT 50 HZ

MEI ≥ 0,40

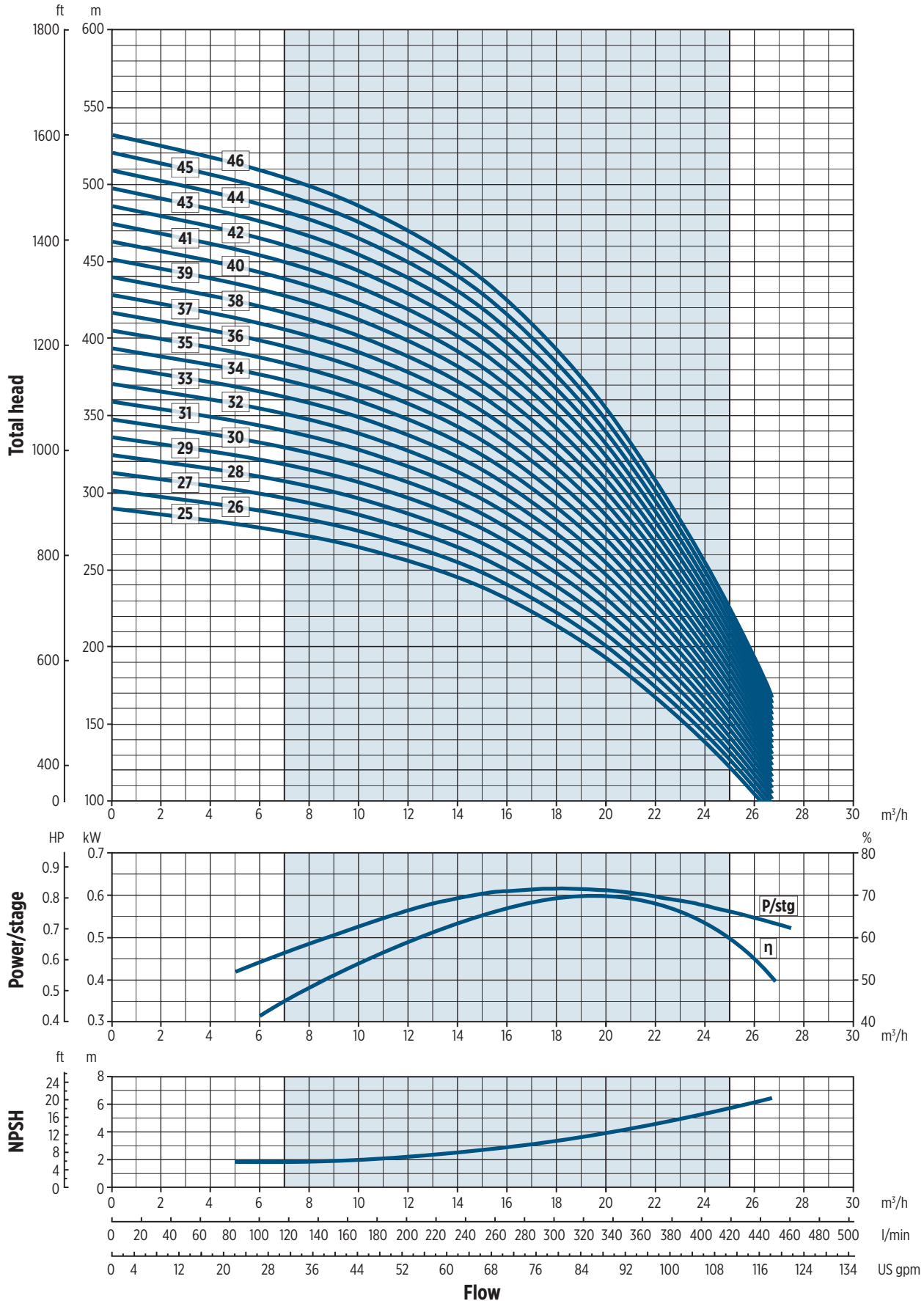

The hydraulic characteristics are guaranteed, according to ISO standard 9906:2012, grade 3B

VS 19 HIGH PRESSURE - TECHNICAL DATA

PUMPS WITH ENCAPSULATED MOTOR

Pump model	Motor			Dimensions					Pump weight [Kg]
	Type	[kW]	[HP]	L1 [mm]	L2 [mm]	Lt [mm]	D [mm]		
							1 cable	2 cable	
VS 19/47	E6	30	40	2031,5	1036,5	3068	145	146,5	131,5
VS 19/48		30	40	2069	1036,5	3105,5	145	146,5	132
VS 19/49		30	40	2106,5	1036,5	3143	145	146,5	134
VS 19/50		37	50	2144	1421,5	3565,5	145	146,5	189
VS 19/51		37	50	2181,5	1421,5	3603	145	146,5	190
VS 19/52		37	50	2219	1421,5	3640,5	145	146,5	191
VS 19/53		37	50	2256,5	1421,5	3678	145	146,5	192
VS 19/54		37	50	2294	1421,5	3715,5	145	146,5	193
VS 19/55		37	50	2331,5	1421,5	3753	145	146,5	194
VS 19/56		37	50	2369	1421,5	3790,5	145	146,5	195
VS 19/57		37	50	2406,5	1421,5	3828	145	146,5	196
VS 19/58		37	50	2444	1421,5	3865,5	145	146,5	197
VS 19/59		37	50	2481,5	1421,5	3903	145	146,5	198
VS 19/60		37	50	2519	1421,5	3940,5	145	146,5	199

PUMPS WITH REWINDABLE MOTOR

Pump model	Motor			Dimensions					Pump weight [Kg]
	Type	[kW]	[HP]	L1 [mm]	L2 [mm]	Lt [mm]	D [mm]		
							1 cable	2 cable	
VS 19/47	RW6	30	40	2031,5	1214	3245,5	149	149,5	147,5
VS 19/48		30	40	2069	1214	3283	149	149,5	148
VS 19/49		30	40	2106,5	1214	3320,5	149	149,5	150
VS 19/50		37	50	2144	1294	3438	149	149,5	158
VS 19/51		37	50	2181,5	1294	3475,5	149	149,5	159
VS 19/52		37	50	2219	1294	3513	149	149,5	160
VS 19/53		37	50	2256,5	1294	3550,5	149	149,5	161
VS 19/54		37	50	2294	1294	3588	149	149,5	162
VS 19/55		37	50	2331,5	1294	3625,5	149	149,5	163
VS 19/56		37	50	2369	1294	3663	149	149,5	164
VS 19/57		37	50	2406,5	1294	3700,5	149	149,5	165
VS 19/58		37	50	2444	1294	3738	149	149,5	166
VS 19/59		37	50	2481,5	1294	3775,5	149	149,5	167
VS 19/60		37	50	2519	1294	3813	149	149,5	168

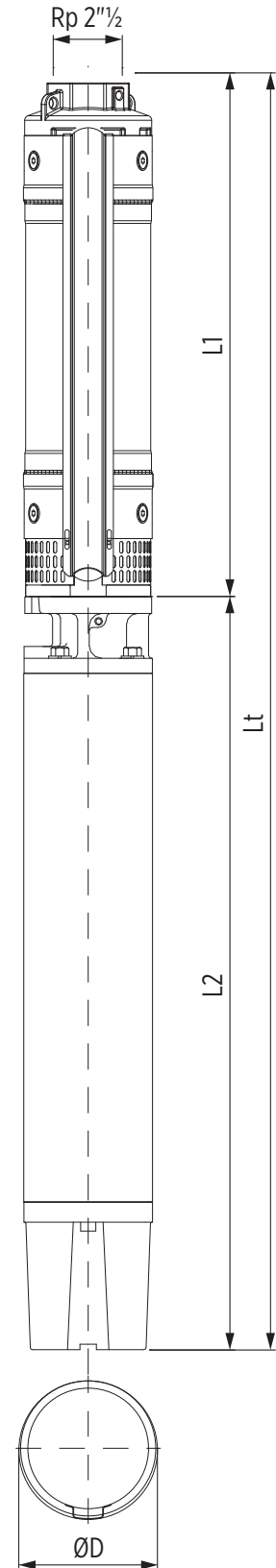

00103057_07/2017

VS 19 HIGH PRESSURE - PERFORMANCE CURVES AT 50 HZ

MEI ≥ 0,40

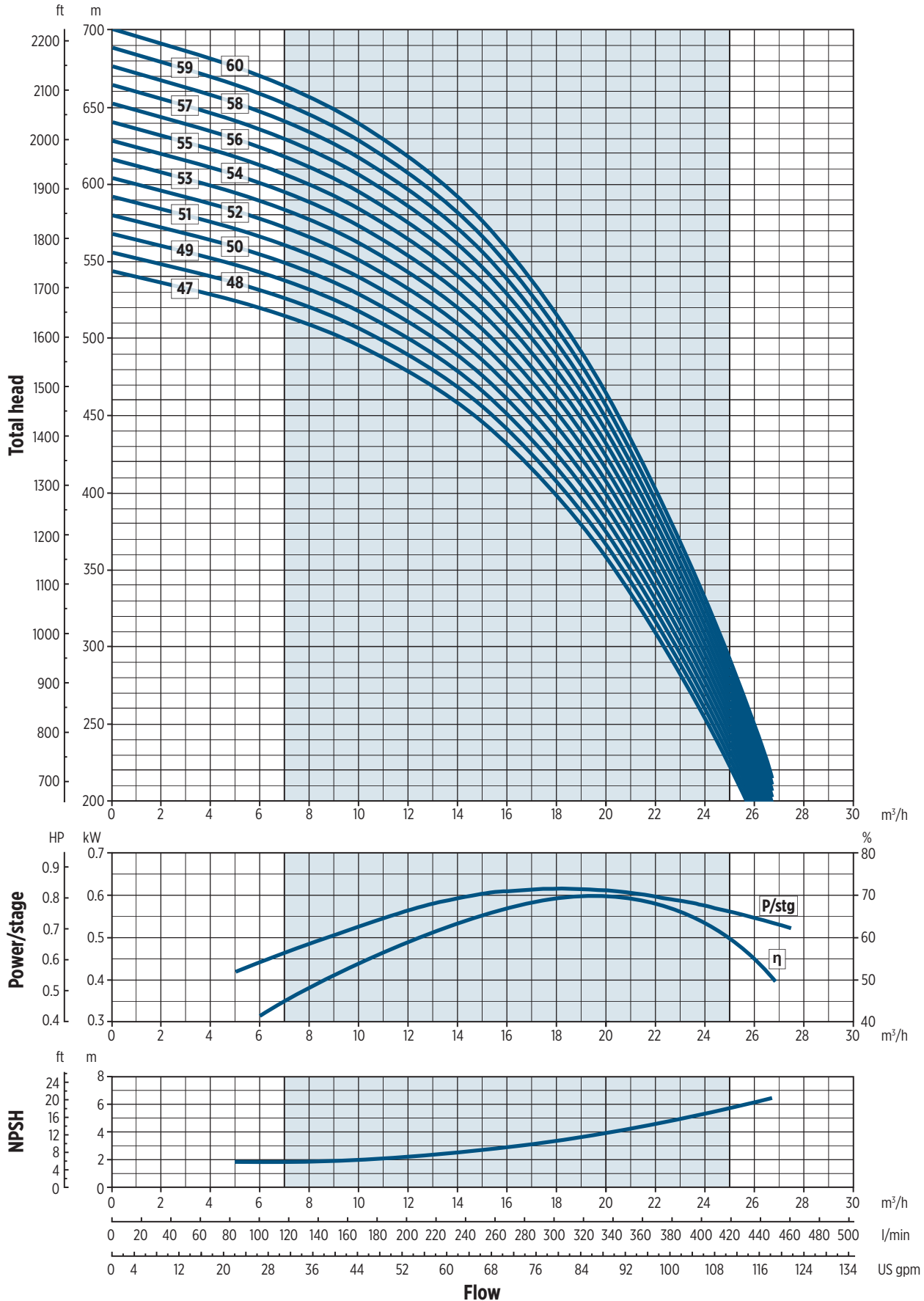

The hydraulic characteristics are guaranteed, according to ISO standard 9906:2012, grade 3B

VS 25 * - TECHNICAL DATA

* IMPORTANT: Models only for sales out of EU or as a component of fire-fighting units

PUMPS WITH ENCAPSULATED MOTOR

Pump model	Motor			Dimensions					Pump weight [Kg]
	Type	[kW]	[HP]	L1 [mm]	L2 [mm]	Lt [mm]	D [mm]		
							1 cable	2 cables	
VS25/3	E4 HT *	3	4	461	477	938	142,5	-	28,5
VS25/4		4	5,5	507,5	543	1050,5	142,5	-	32,5
VS25/5		5,5	7,5	554	652,5	1206,5	142,5	-	40
VS25/6		7,5	10	600,5	730,5	1331	142,5	-	45
VS25/7		7,5	1	647	730,5	1377,5	142,5	-	46

* Kit 14251005 necessary for 4" motors

VS25/3	E6	4	5,5	458,5	581	1039,5	143	144,5	49
VS25/4		4	5,5	505	581	1086	143	144,5	50
VS25/5		5,5	7,5	551,5	614,5	1166	143	144,5	54,5
VS25/6		7,5	1	598	646	1244	143	144,5	59,5
VS25/7		7,5	10	644,5	646	1290,5	143	144,5	60,5
VS25/8		9,3	12,5	691	678,5	1369,5	143	144,5	64
VS25/9		9,3	12,5	737,5	678,5	1416	143	144,5	65
VS25/10		11	15	784	711	1495	143	144,5	70
VS25/11		11	15	830,5	711	1541,5	143	144,5	70,5
VS25/12		15	2	877	776	1653	143	144,5	77,5
VS25/13		15	2	923,5	776	1699,5	143	144,5	79
VS25/14		15	2	97	776	1746	143	144,5	79
VS25/15		15	2	1016,5	776	1792,5	143	144,5	79,5
VS25/16		18,5	25	1063	841,5	1904,5	143	144,5	88
VS25/17		18,5	25	1109,5	841,5	1951	143	144,5	88,5
VS25/18		18,5	25	1156	841,5	1997,5	143	144,5	89,5
VS25/19		18,5	25	1202,5	841,5	2044	143	144,5	90,5
VS25/20		22	3	1249	906,5	2155,5	143	144,5	97,5
VS25/21		22	30	1295,5	906,5	2202	143	144,5	98,5
VS25/22		22	3	1342	906,5	2248,5	143	144,5	99,5
VS25/23		22	30	1388,5	906,5	2295	143	144,5	100,5

PUMPS WITH REWINDABLE MOTOR

Pump model	Motor			Dimensions					Pump weight [Kg]
	Type	[kW]	[HP]	L1 [mm]	L2 [mm]	Lt [mm]	D [mm]		
							1 cable	2 cables	
VS25/3	RW6	4	5,5	458,5	699	1157,5	147	147,5	59,5
VS25/4		4	5,5	505	699	1204	147	147,5	60,5
VS25/5		5,5	7,5	551,5	699	1250,5	147	147,5	61,5
VS25/6		7,5	1	598	719	1317	147	147,5	64,5
VS25/7		7,5	1	644,5	719	1363,5	147	147,5	65,5
VS25/8		9,3	12,5	691	749	144	147	147,5	69,5
VS25/9		9,3	12,5	737,5	749	1486,5	147	147,5	70,5
VS25/10		11	15	784	779	1563	147	147,5	75
VS25/11		11	15	830,5	779	1609,5	147	147,5	75,5
VS25/12		13	17,5	877	829	1706	147	147,5	82
VS25/13		13	17,5	923,5	829	1752,5	147	147,5	83,5
VS25/14		15	2	97	874	1844	147	147,5	88,5
VS25/15		15	20	1016,5	874	1890,5	147	147,5	89
VS25/16		18,5	25	1063	919	1982	147	147,5	94,5
VS25/17		18,5	25	1109,5	919	2028,5	147	147,5	95
VS25/18		18,5	25	1156	919	2075	147	147,5	96
VS25/19		18,5	25	1202,5	919	2121,5	147	147,5	97
VS25/20		22	30	1249	1009	2258	147	147,5	107
VS25/21		22	30	1295,5	1009	2304,5	147	147,5	108
VS25/22		22	30	1342	1009	2351	147	147,5	109
VS25/23		22	30	1388,5	1009	2397,5	147	147,5	110

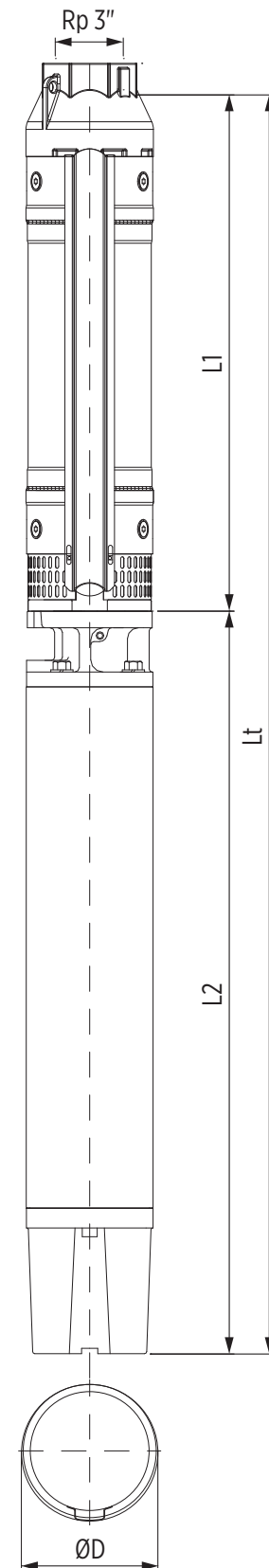

0010246 06/2021

VS 25 * - PERFORMANCE CURVES AT 50 HZ

* IMPORTANT: Models only for sales out of EU or as a component of fire-fighting units

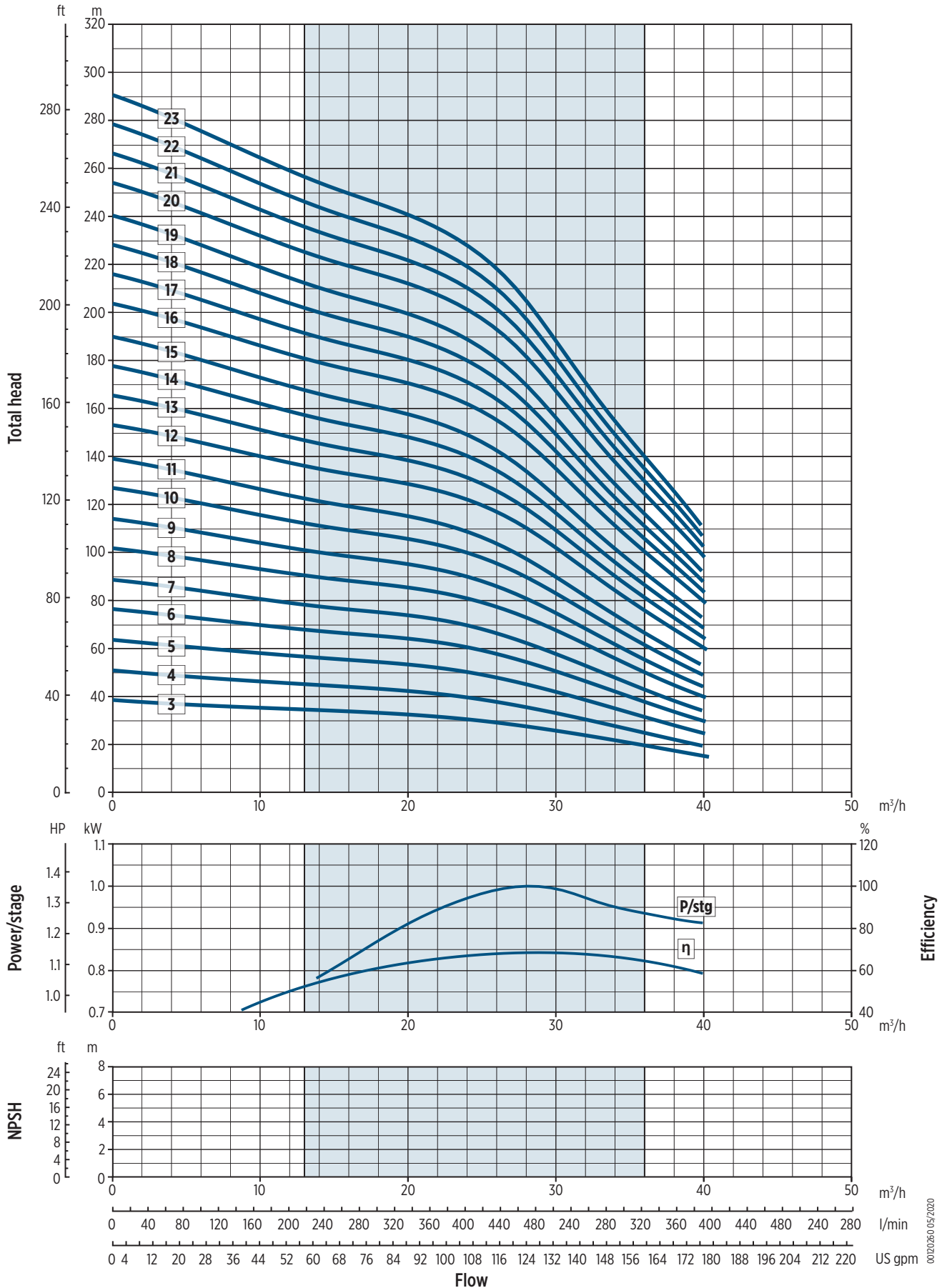

The hydraulic characteristics are guaranteed, according to ISO standard 9906:2012, grade 3B

VS 30 - TECHNICAL DATA

PUMPS WITH ENCAPSULATED MOTOR

Pump model	Motor			Dimensions					Pump weight [Kg]
	Type	[kW]	[HP]	L1 [mm]	L2 [mm]	Lt [mm]	D [mm]		
							1 cable	2 cable	
VS 30/3	E4	3.7	5	622	520	1142	142.5	-	34
VS 30/4		5.5	7.5	707.5	652.5	1360	142.5	-	43.5
VS 30/5		7.5	10	793	730.5	1523.5	142.5	-	50
VS 30/6		7.5	10	878.5	730.5	1609	142.5	-	52

* Kit 14251005 necessary for 4" motors

VS 30/3	E6	4	5.5	620	581	1201	143	144.5	52	
VS 30/4		5.5	7.5	705.5	614.5	1320	143	144.5	58	
VS 30/5		7.5	10	790.5	646	1436.5	143	144.5	64	
VS 30/6		7.5	10	876	646	1522	143	144.5	66	
VS 30/7		9.3	12.5	961.5	678.5	1640	143	144.5	70.5	
VS 30/8		11	15	1047	711	1758	143	144.5	76.5	
VS 30/9		11	15	1132.5	711	1843.5	143	144.5	78.5	
VS 30/10		15	20	1218	776	1994	143	144.5	86	
VS 30/11		15	20	1303.5	776	2079.5	143	144.5	88	
VS 30/12		15	20	1389	776	2165	143	144.5	90	
VS 30/13		18.5	25	1474.5	841.5	2316	143	144.5	99	
VS 30/14		18.5	25	1560	841.5	2401.5	143	144.5	101.5	
VS 30/15		22	30	1645.5	906.5	2552	143	144.5	109.5	
VS 30/16		22	30	1730.5	906.5	2637	143	144.5	111.5	
VS 30/17		22	30	1816	906.5	2722.5	143	144.5	113.5	
VS 30/18		22	30	1901.5	906.5	2808	143	144.5	115.5	
VS 30/19		30	40	1987	1036.5	3023.5	143	144.5	132	
VS 30/20		E6	30	40	2072.5	1036.5	3109	143	144.5	134.5

PUMPS WITH REWINDABLE MOTOR

Pump model	Vers. R	Motor			Dimensions					Pump weight [Kg]
		Type	[kW]	[HP]	L1 [mm]	L2 [mm]	Lt [mm]	D [mm]		
								1 cable	2 cable	
VS 30/3	●	RW6	4	5.5	620	699	1319	147	147.5	62.5
VS 30/4	●		5.5	7.5	705.5	699	1404.5	147	147.5	65
VS 30/5	●		7.5	10	790.5	719	1509.5	147	147.5	69
VS 30/6	●		7.5	10	876	719	1595	147	147.5	71
VS 30/7	●		9.3	12.5	961.5	749	1710.5	147	147.5	76
VS 30/8	●		11	15	1047	779	1826	147	147.5	81.5
VS 30/9	●		11	15	1132.5	779	1911.5	147	147.5	83.5
VS 30/10	●		13	17.5	1218	829	2047	147	147.5	90.5
VS 30/11	●		15	20	1303.5	874	2177.5	147	147.5	97.5
VS 30/12	●		15	20	1389	874	2263	147	147.5	99.5
VS 30/13	●		18.5	25	1474.5	919	2393.5	147	147.5	105.5
VS 30/14	●		18.5	25	1560	919	2479	147	147.5	108
VS 30/15	●		22	30	1645.5	1009	2654.5	147	147.5	119
VS 30/16	●		22	30	1730.5	1009	2739.5	147	147.5	121
VS 30/17	●		22	30	1816	1009	2825	147	147.5	123
VS 30/18	●		22	30	1901.5	1009	2910.5	147	147.5	125
VS 30/19	●		26	35	1987	1114	3101	147	147.5	138
VS 30/20	●		26	35	2072.5	1114	3186.5	147	147.5	140.5

● = Pump available in R (AISI 904L) version

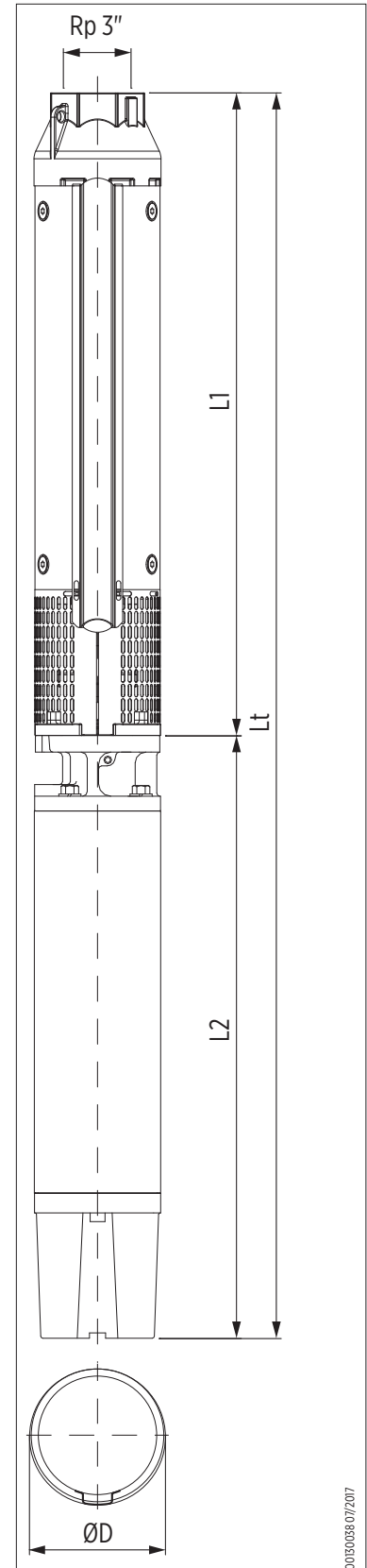

0030038 07/2017

VS 30 - PERFORMANCE CURVES AT 50 HZ

MEI ≥ 0,40

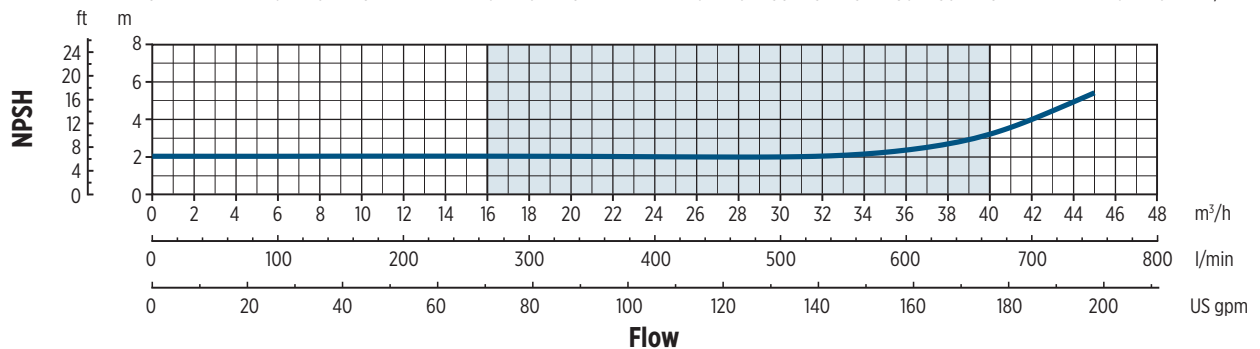
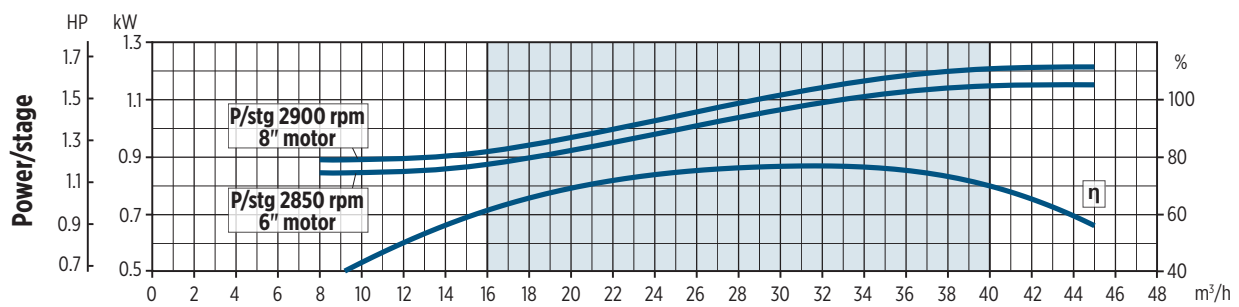
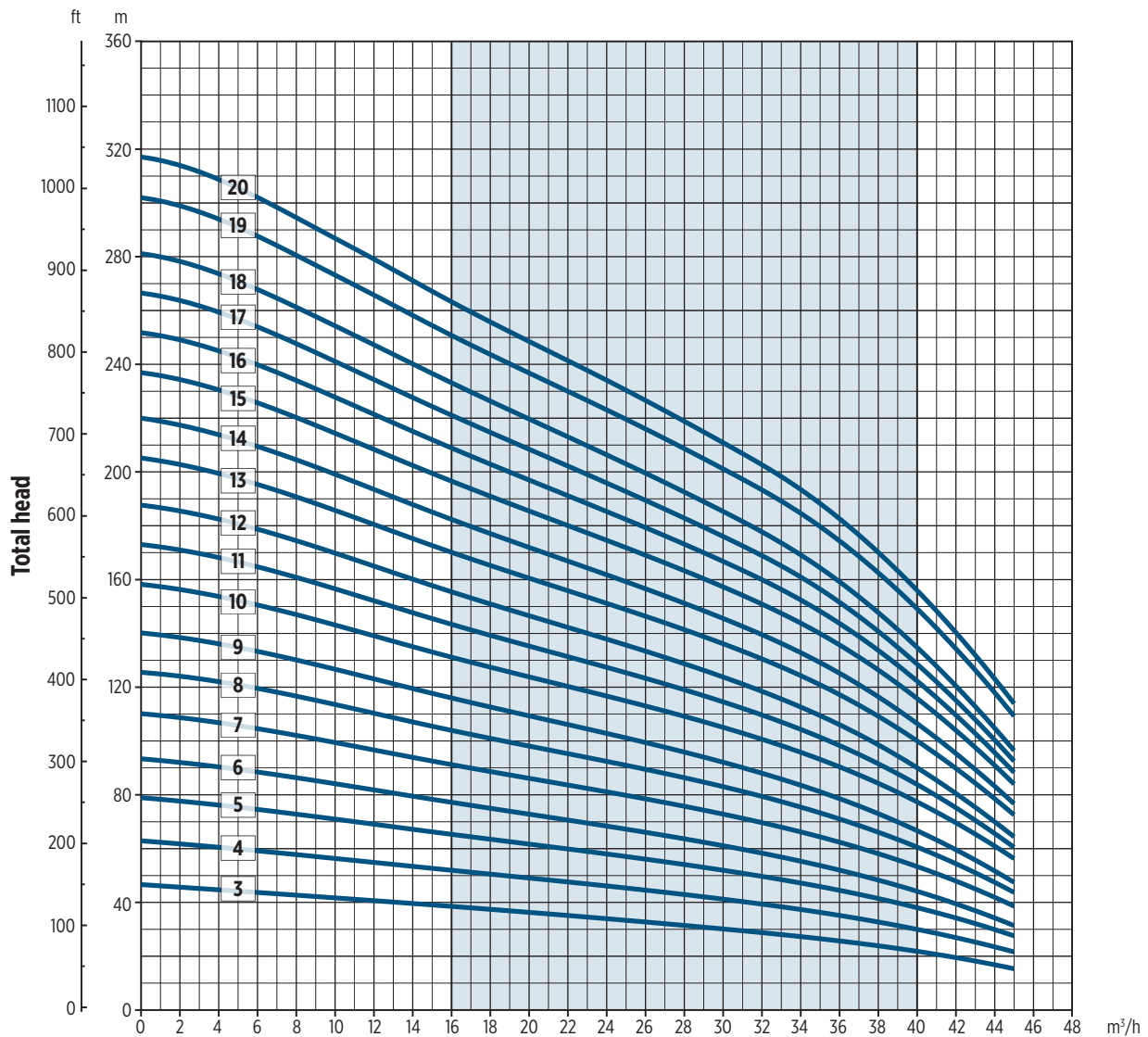

The hydraulic characteristics are guaranteed, according to ISO standard 9906:2012, grade 3B

VS 30 - TECHNICAL DATA

PUMPS WITH ENCAPSULATED MOTOR

Pump model	Motor			Dimensions					Pump weight [Kg]
	Type	[kW]	[HP]	L1 [mm]	L2 [mm]	Lt [mm]	D [mm]		
							1 cable	2 cable	
VS 30/21	E6	30	40	2157.5	1036.5	3194	143	144.5	136.5
VS 30/22		30	40	2243	1036.5	3279.5	143	144.5	138.5
VS 30/23		30	40	2328.5	1036.5	3365	143	144.5	140.5
VS 30/24		30	40	2414	1036.5	3450.5	143	144.5	142.5
VS 30/25		37	50	2499	1421.5	3920.5	143	144.5	199
VS 30/26		37	50	2584.5	1421.5	4006	143	144.5	201
VS 30/27		37	50	2670	1421.5	4091.5	143	144.5	203
VS 30/28		37	50	2755	1421.5	4176.5	143	144.5	205
VS 30/29		37	50	2840.5	1421.5	4262	143	144.5	207
VS 30/30		37	50	2926	1421.5	4347.5	143	144.5	209.5
VS 30/31		45	60	3011	1574	4585	143	144.5	224.5
VS 30/32		45	60	3096.5	1574	4670.5	143	144.5	227.5
VS 30/33		45	60	3182	1574	4756	143	144.5	229.5
VS 30/34		45	60	3267.5	1574	4841.5	143	144.5	231.5
VS 30/35		45	60	3352.5	1574	4926.5	143	144.5	234

PUMPS WITH REWINDABLE MOTOR

Pump model	Vers. R	Motor			Dimensions					Pump weight [Kg]
		Type	[kW]	[HP]	L1 [mm]	L2 [mm]	Lt [mm]	D [mm]		
								1 cable	2 cable	
VS 30/21	●	RW6	26	35	2157.5	1114	3271.5	147	147.5	142.5
VS 30/22	●		30	40	2243	1214	3457	147	147.5	154.5
VS 30/23	●		30	40	2328.5	1214	3542.5	147	147.5	156.5
VS 30/24	●		30	40	2414	1214	3628	147	147.5	158.5
VS 30/25	●		37	50	2499	1294	3793	147	147.5	168
VS 30/26	●		37	50	2584.5	1294	3878.5	147	147.5	170
VS 30/27	●		37	50	2670	1294	3964	147	147.5	172
VS 30/28	●		37	50	2755	1294	4049	147	147.5	174
VS 30/29	●		37	50	2840.5	1294	4134.5	147	147.5	176
VS 30/30	●		37	50	2926	1294	4220	147	147.5	178.5
VS 30/31		RW8	45	60	3111	1230	4341	189	189	234.5
VS 30/32			45	60	3196.5	1230	4426.5	189	189	237.5
VS 30/33			45	60	3282	1230	4512	189	189	239.5
VS 30/34			45	60	3367.5	1230	4597.5	189	189	241.5
VS 30/35			45	60	3452.5	1230	4682.5	189	189	244

● = Pump available in R (AISI 904L) version

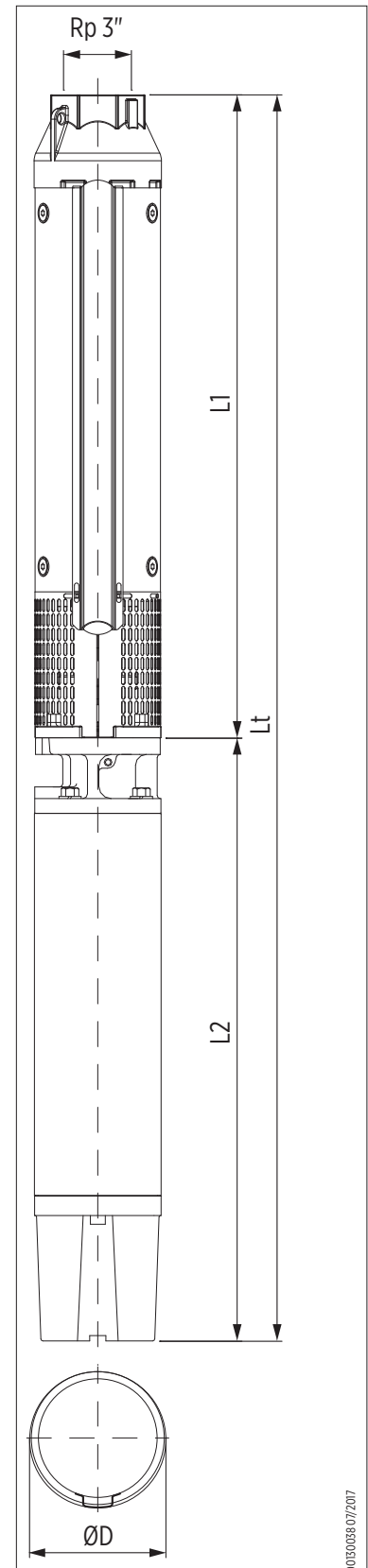

0030038 07/207

VS 30 - PERFORMANCE CURVES AT 50 HZ

MEI ≥ 0,40

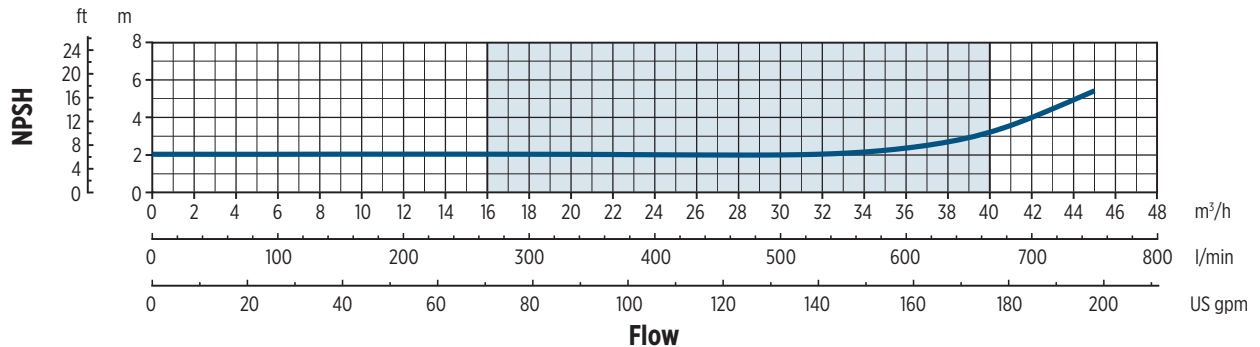
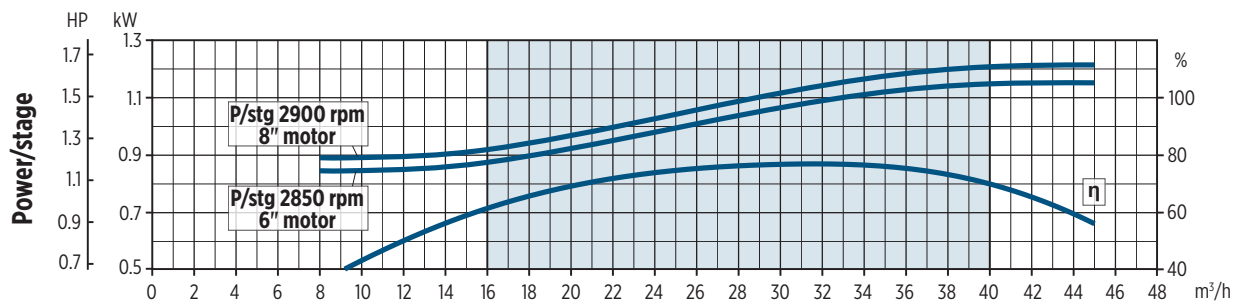
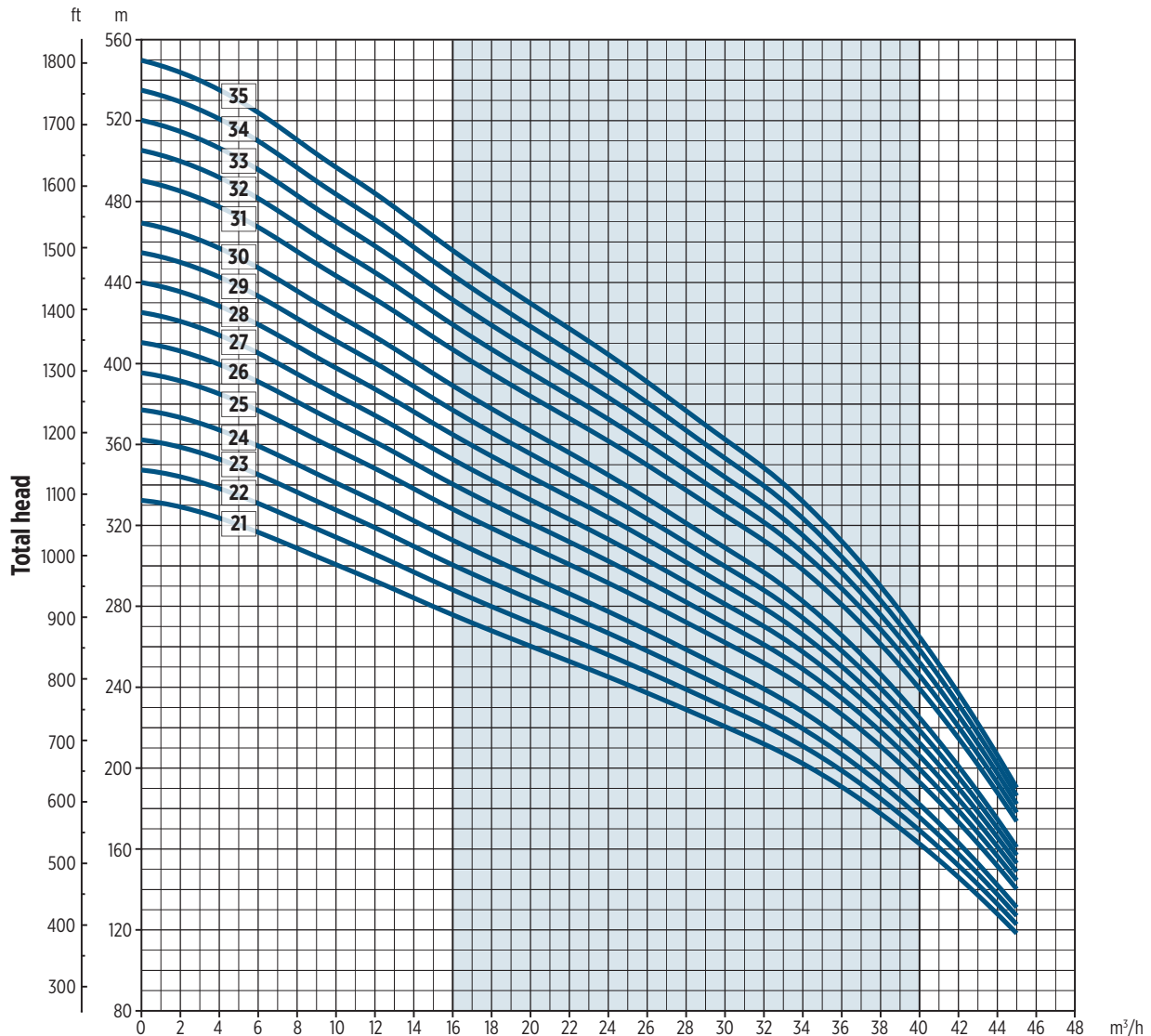

The hydraulic characteristics are guaranteed, according to ISO standard 9906:2012, grade 3B

VS 30 HIGH PRESSURE - TECHNICAL DATA

PUMPS WITH ENCAPSULATED MOTOR

Pump model	Motor			Dimensions					Pump weight [Kg]
	Type	[kW]	[HP]	L1 [mm]	L2 [mm]	Lt [mm]	D [mm]		
							1 cable	2 cable	
VS 30/36	E6	45	60	3438	1574	5012	145	146.5	237
VS 30/37		45	60	3523.5	1574	5097.5	145	146.5	239
VS 30/38	E8	55	75	3709	1204	4913	190.5	190.5	270.5
VS 30/39		55	75	3794	1204	4998	190.5	190.5	272.5
VS 30/40		55	75	3879.5	1204	5083.5	190.5	190.5	275
VS 30/41		55	75	3965	1204	5169	190.5	190.5	276
VS 30/42		55	75	4050.5	1204	5254.5	190.5	190.5	277
VS 30/43		55	75	4135.5	1204	5339.5	190.5	190.5	278

PUMPS WITH REWINDABLE MOTOR

Pump model	Motor			Dimensions					Pump weight [Kg]
	Type	[kW]	[HP]	L1 [mm]	L2 [mm]	Lt [mm]	D [mm]		
							1 cable	2 cable	
VS 30/36	RW8	45	60	3538	1230	4768	189	189	247
VS 30/37		45	60	3623.5	1230	4853.5	189	189	249
VS 30/38		55	75	3709	1340	5049	189	189	274.5
VS 30/39		55	75	3794	1340	5134	189	189	276.5
VS 30/40		55	75	3879.5	1340	5219.5	189	189	279
VS 30/41		55	75	3965	1340	5305	189	189	280
VS 30/42		55	75	4050.5	1340	5390.5	189	189	281
VS 30/43		55	75	4135.5	1340	5475.5	189	189	282

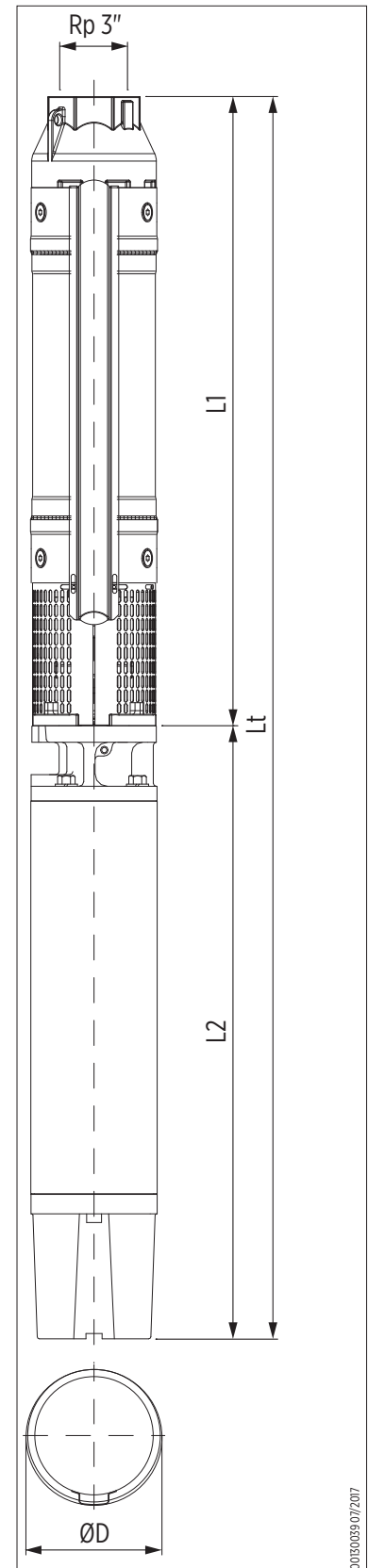

00103005907/2017

VS 30 HIGH PRESSURE - PERFORMANCE CURVES AT 50 HZ

MEI ≥ 0,40

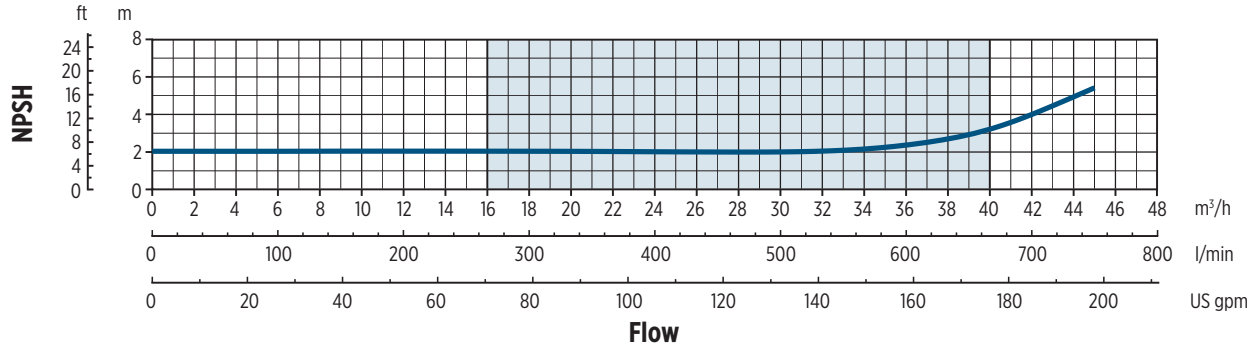
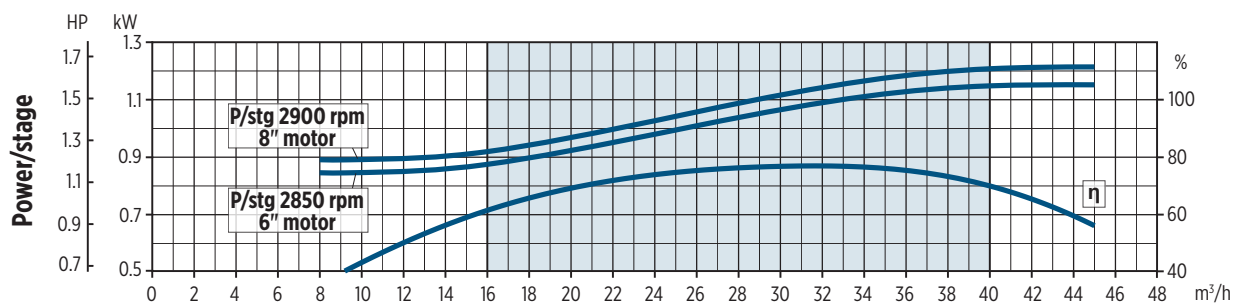
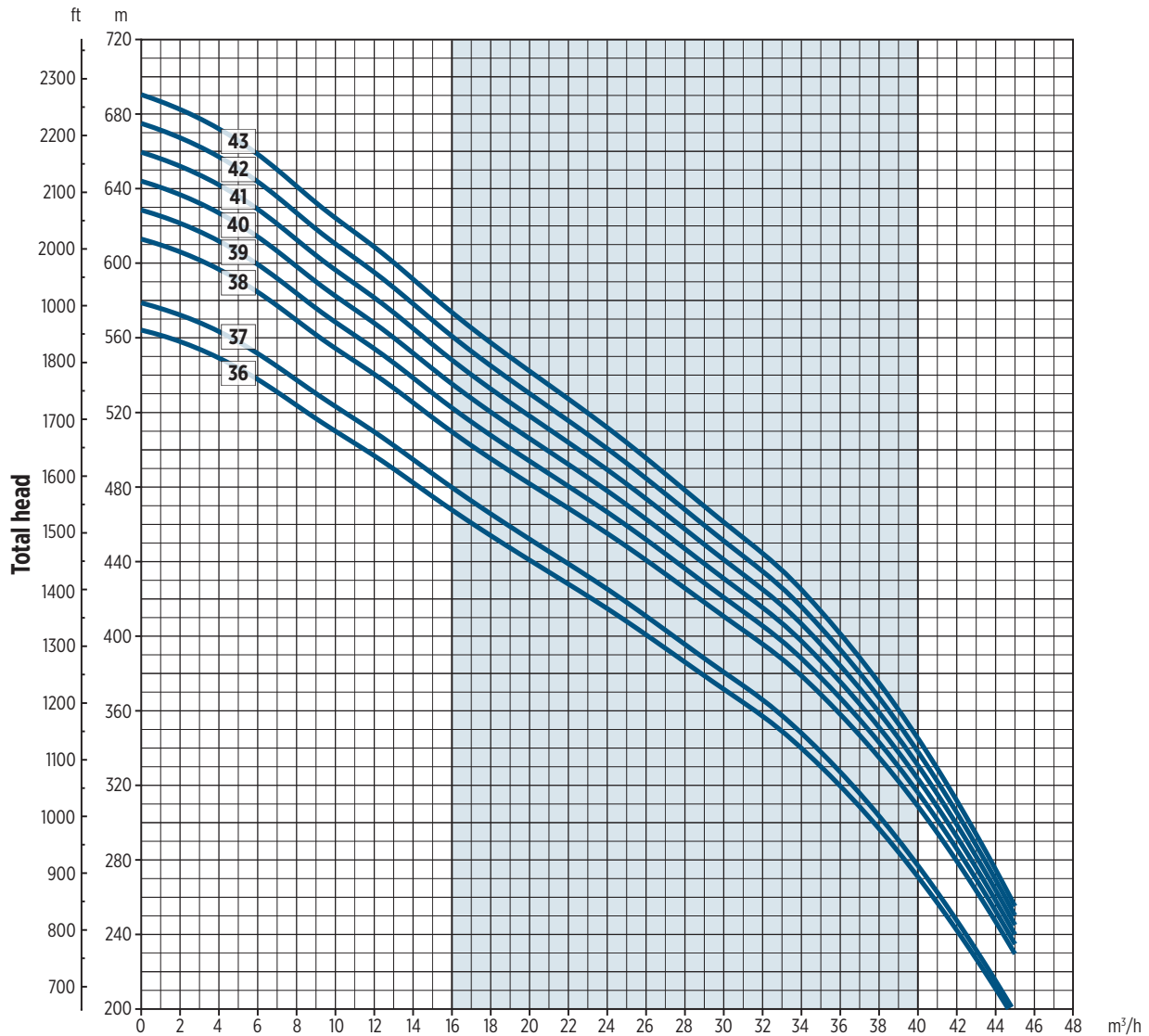

The hydraulic characteristics are guaranteed, according to ISO standard 9906:2012, grade 3B

VS 46 - TECHNICAL DATA

PUMPS WITH ENCAPSULATED MOTOR

Pump model	Motor			Dimensions					Pump weight [Kg]
	Type	[kW]	[HP]	L1 [mm]	L2 [mm]	Lt [mm]	D [mm]		
							1 cable	2 cable	
VS 46/2	E4 *	3	4	593.5	477	1070.5	142.5	-	31
VS 46/3		4	5.5	707.5	543	1250.5	142.5	-	36.5
VS 46/4		5.5	7.5	821.5	652.5	1474	142.5	-	45.5
VS 46/5		7.5	10	935.5	730.5	1666	142.5	-	52.5

* Kit 14251005 necessary for 4" motors

VS 46/2	E6	4	5.5	591.5	581	1172.5	143	144.5	51
VS 46/3		4	5.5	705.5	581	1286.5	143	144.5	53.5
VS 46/4		5.5	7.5	819.5	614.5	1434	143	144.5	60
VS 46/5		7.5	10	933.5	646	1579.5	143	144.5	66.5
VS 46/6		9.3	12.5	1047	678.5	1725.5	143	144.5	71.5
VS 46/7		9.3	12.5	1161	678.5	1839.5	143	144.5	74
VS 46/8		11	15	1275	711	1986	143	144.5	80
VS 46/9		15	20	1389	776	2165	143	144.5	88.5
VS 46/10		15	20	1503	776	2279	143	144.5	91
VS 46/11		15	20	1617	776	2393	143	144.5	93.5
VS 46/12		18.5	25	1730.5	841.5	2572	143	144.5	103
VS 46/13		18.5	25	1844.5	841.5	2686	143	144.5	105.5
VS 46/14		18.5	25	1958.5	841.5	2800	143	144.5	108.5
VS 46/15		22	30	2072.5	906.5	2979	143	144.5	117
VS 46/16		22	30	2186	906.5	3092.5	143	144.5	119.5
VS 46/17		22	30	2300	906.5	3206.5	143	144.5	122
VS 46/18		30	40	2414	1036.5	3450.5	143	144.5	139.5
VS 46/19		30	40	2527.5	1036.5	3564	143	144.5	142
VS 46/20		30	40	2641.5	1036.5	3678	143	144.5	144.5
VS 46/21		30	40	2755	1036.5	3791.5	143	144.5	147
VS 46/22		30	40	2869	1036.5	3905.5	143	144.5	149.5
VS 46/23		30	40	2983	1036.5	4019.5	143	144.5	152.5
VS 46/24		37	50	3096.5	1421.5	4518	143	144.5	209
VS 46/25		37	50	3210.5	1421.5	4632	143	144.5	211.5
VS 46/26		37	50	3324	1421.5	4745.5	143	144.5	214

PUMPS WITH REWINDABLE MOTOR

Pump model	Vers. R	Motor			Dimensions					Pump weight [Kg]
		Type	[kW]	[HP]	L1 [mm]	L2 [mm]	Lt [mm]	D [mm]		
								1 cable	2 cable	
VS 46/2	●	RW6	4	5.5	591.5	699	1290.5	147	147.5	61.5
VS 46/3	●		4	5.5	705.5	699	1404.5	147	147.5	64
VS 46/4	●		5.5	7.5	819.5	699	1518.5	147	147.5	67
VS 46/5	●		7.5	10	933.5	719	1652.5	147	147.5	71.5
VS 46/6	●		9.3	12.5	1047	749	1796	147	147.5	77
VS 46/7	●		9.3	12.5	1161	749	1910	147	147.5	79.5
VS 46/8	●		11	15	1275	779	2054	147	147.5	85
VS 46/9	●		13	17.5	1389	829	2218	147	147.5	93
VS 46/10	●		13	17.5	1503	829	2332	147	147.5	95.5
VS 46/11	●		15	20	1617	874	2491	147	147.5	103
VS 46/12	●		18.5	25	1730.5	919	2649.5	147	147.5	109.5
VS 46/13	●		18.5	25	1844.5	919	2763.5	147	147.5	112
VS 46/14	●		18.5	25	1958.5	919	2877.5	147	147.5	115
VS 46/15	●		22	30	2072.5	1009	3081.5	147	147.5	126.5
VS 46/16	●		22	30	2186	1009	3195	147	147.5	129
VS 46/17	●		22	30	2300	1009	3309	147	147.5	131.5
VS 46/18	●		26	35	2414	1114	3528	147	147.5	145.5
VS 46/19	●		26	35	2527.5	1114	3641.5	147	147.5	148
VS 46/20	●		30	40	2641.5	1214	3855.5	147	147.5	160.5
VS 46/21	●		30	40	2755	1214	3969	147	147.5	163
VS 46/22	●		30	40	2869	1214	4083	147	147.5	165.5
VS 46/23	●		30	40	2983	1214	4197	147	147.5	168.5
VS 46/24	●		37	50	3096.5	1294	4390.5	147	147.5	178
VS 46/25	●		37	50	3210.5	1294	4504.5	147	147.5	180.5
VS 46/26	●		37	50	3324	1294	4618	147	147.5	183

● = Pump available in R (AISI 904L) version

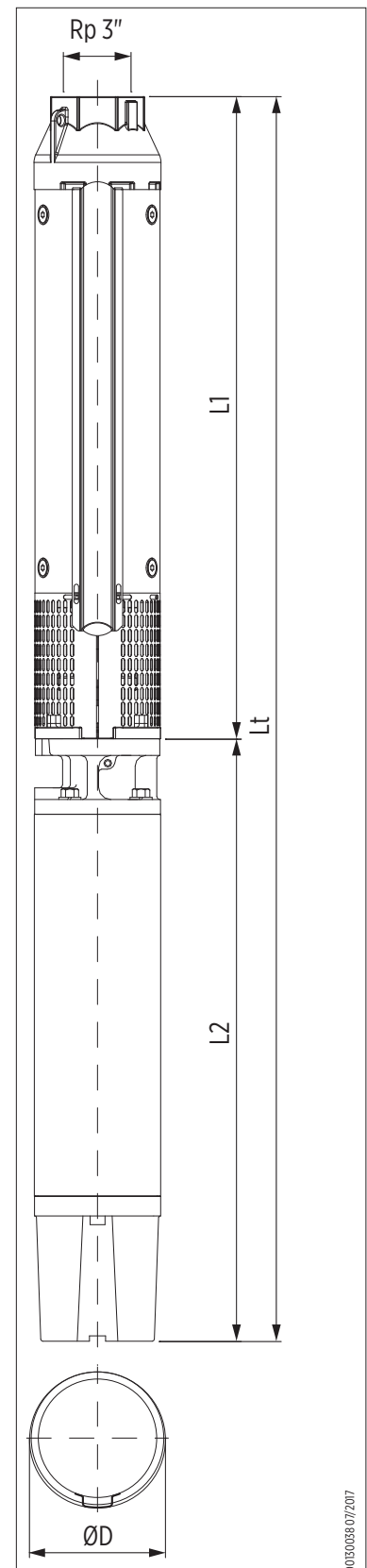

0030038 07/207

VS 46 - PERFORMANCE CURVES AT 50 HZ

MEI ≥ 0,40

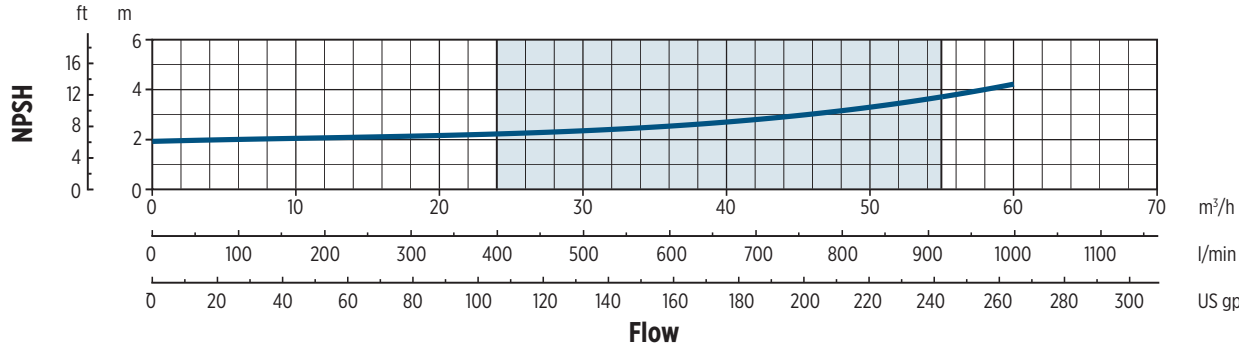
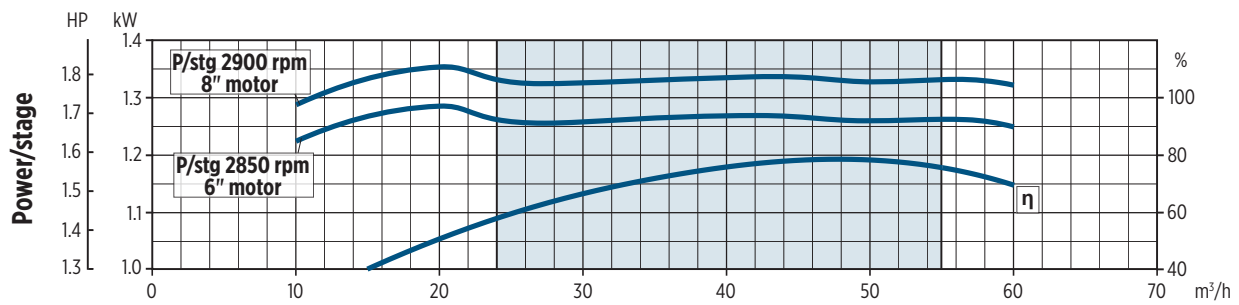
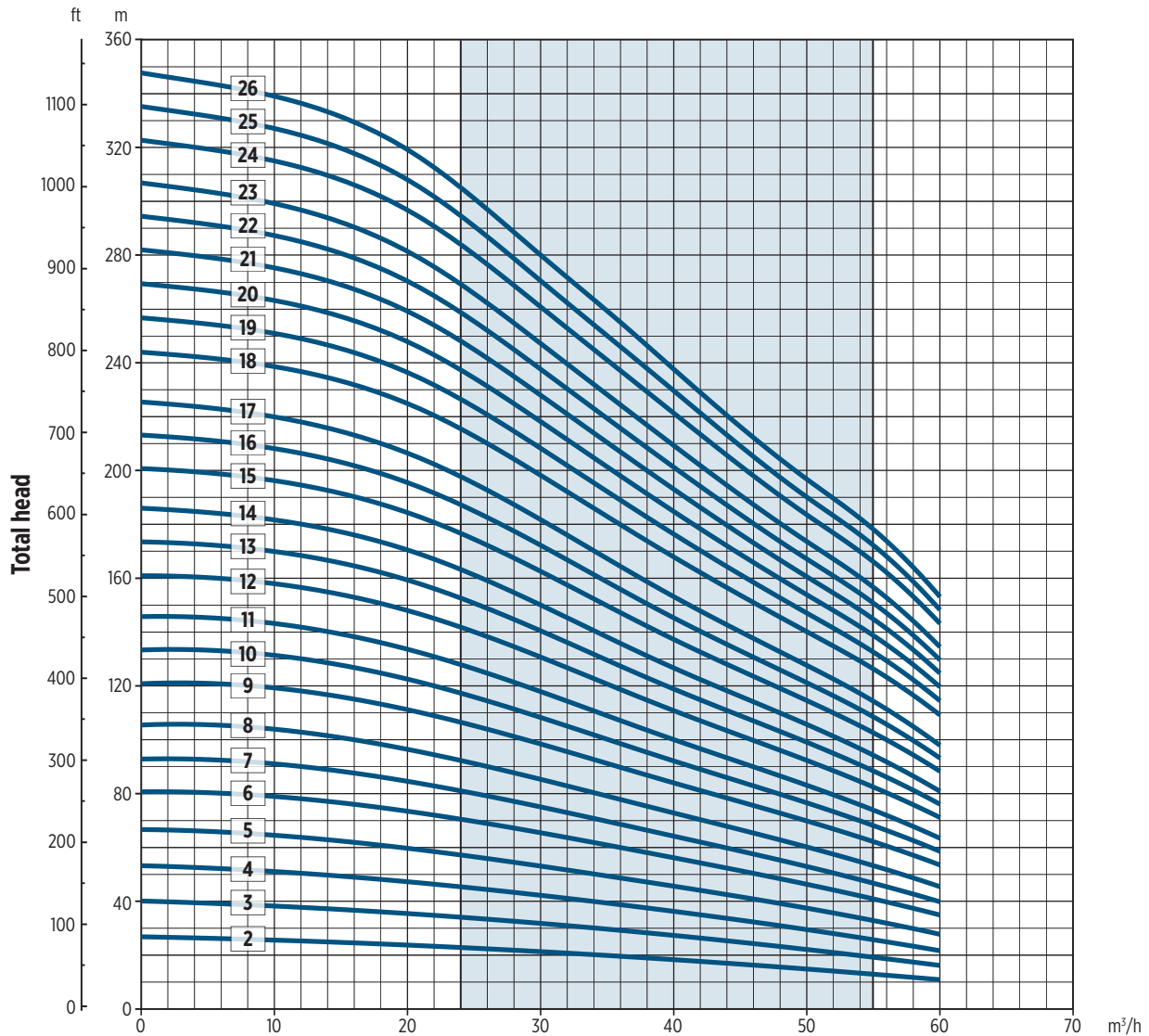

The hydraulic characteristics are guaranteed, according to ISO standard 9906:2012, grade 3B

VS 46 HIGH PRESSURE - TECHNICAL DATA

PUMPS WITH ENCAPSULATED MOTOR

Pump model	Motor			Dimensions					Pump weight [Kg]
	Type	[kW]	[HP]	L1 [mm]	L2 [mm]	Lt [mm]	D [mm]		
							1 cable	2 cable	
VS 46/27	E6	37	50	3438	1421.5	4859.5	145	146.5	217.5
VS 46/28		37	50	3552	1421.5	4973.5	145	146.5	220
VS 46/29		45	60	3665.5	1574	5239.5	145	146.5	236.5
VS 46/30		45	60	3779.5	1574	5353.5	145	146.5	239
VS 46/31		45	60	3893.5	1574	5467.5	145	146.5	242
VS 46/32		45	60	4007	1574	5581	145	146.5	244.5
VS 46/33		45	60	4121	1574	5695	145	146.5	247
VS 46/34		E8	55	75	4335	1204	5539	190.5	190.5
VS 46/35	55		75	4449	1204	5653	190.5	190.5	281.5
VS 46/36	55		75	4562.5	1204	5766.5	190.5	190.5	284.5
VS 46/37	55		75	4676.5	1204	5880.5	190.5	190.5	287
VS 46/38	55		75	4790.5	1204	5994.5	190.5	190.5	289.5
VS 46/39	55		75	4904.5	1204	6108.5	190.5	190.5	292
VS 46/40	55		75	5018.5	1204	6222.5	190.5	190.5	295

PUMPS WITH REWINDABLE MOTOR

Pump model	Motor			Dimensions					Pump weight [Kg]
	Type	[kW]	[HP]	L1 [mm]	L2 [mm]	Lt [mm]	D [mm]		
							1 cable	2 cable	
VS 46/27	RW6	37	50	3438	1294	4732	149	149.5	186.5
VS 46/28		37	50	3552	1294	4846	149	149.5	189
VS 46/29	RW8	45	60	3765.5	1230	4995.5	189	189	246.5
VS 46/30		45	60	3879.5	1230	5109.5	189	189	249
VS 46/31		45	60	3993.5	1230	5223.5	189	189	252
VS 46/32		45	60	4107	1230	5337	189	189	254.5
VS 46/33		45	60	4221	1230	5451	189	189	257
VS 46/34		55	75	4335	1340	5675	189	189	283
VS 46/35		55	75	4449	1340	5789	189	189	285.5
VS 46/36		55	75	4562.5	1340	5902.5	189	189	288.5
VS 46/37		55	75	4676.5	1340	6016.5	189	189	291
VS 46/38		55	75	4790.5	1340	6130.5	189	189	293.5
VS 46/39		55	75	4904.5	1340	6244.5	189	189	296
VS 46/40		55	75	5018.5	1340	6358.5	189	189	299

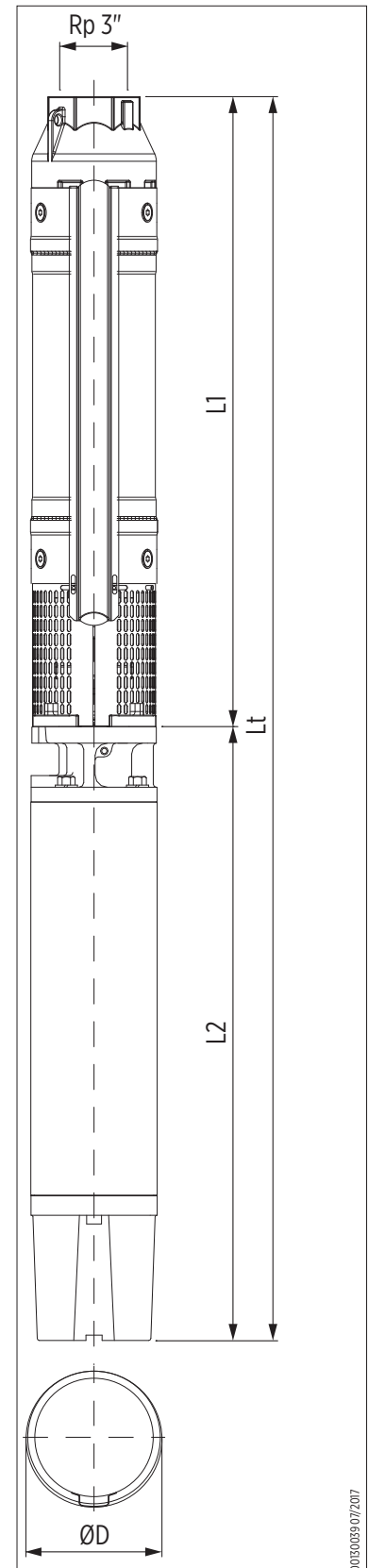

001030039/07/2017

VS 46 HIGH PRESSURE - PERFORMANCE CURVES AT 50 HZ

MEI ≥ 0,40

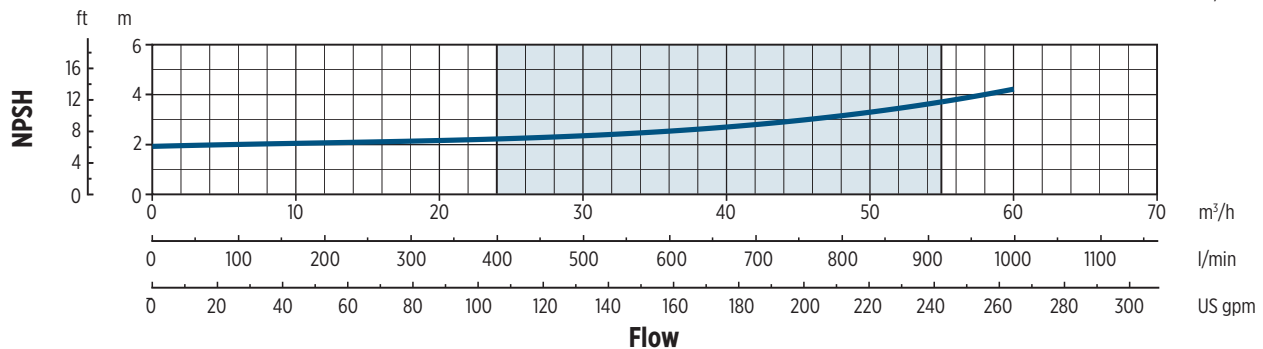
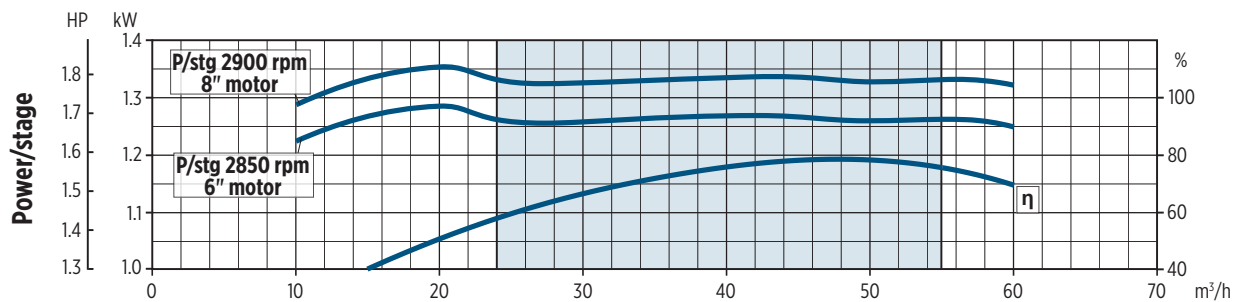
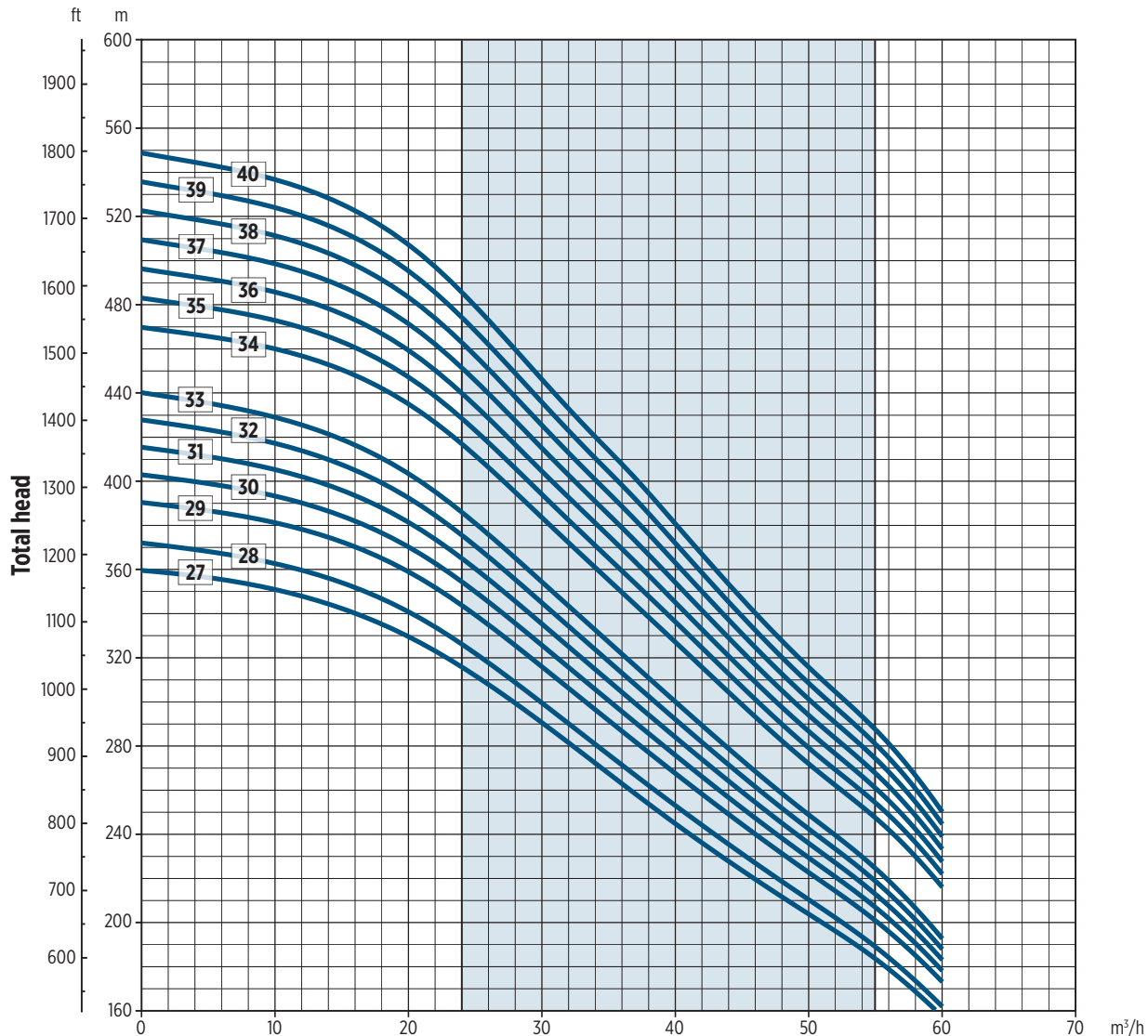

The hydraulic characteristics are guaranteed, according to ISO standard 9906:2012, grade 3B

VS 65 - TECHNICAL DATA

PUMPS WITH ENCAPSULATED MOTOR

Pump model	Motor			Dimensions					Pump weight [Kg]
	Type	[kW]	[HP]	L1 [mm]	L2 [mm]	Lt [mm]	D [mm]		
							1 cable	2 cable	
VS 65/2	E4 *	3.7	5	593.5	520	1113.5	142.5	-	33
VS 65/3		5.5	7.5	707.5	652.5	1360	142.5	-	43
VS 65/4		7.5	10	821.5	730.5	1552	142.5	-	49.5

* Kit 14251005 necessary for 4" motors

Pump model	Type	Motor		Dimensions					Pump weight [Kg]
		[kW]	[HP]	L1 [mm]	L2 [mm]	Lt [mm]	D [mm]		
VS 65/2	E6	4	5.5	591.5	581	1172.5	143	144.5	51
VS 65/3		5.5	7.5	705.5	614.5	1320	143	144.5	57
VS 65/4		7.5	10	819.5	646	1465.5	143	144.5	64
VS 65/5		9.3	12.5	933.5	678.5	1612	143	144.5	69
VS 65/6		11	15	1047	711	1758	143	144.5	75
VS 65/7		15	20	1161	776	1937	143	144.5	83
VS 65/8		15	20	1275	776	2051	143	144.5	86
VS 65/9		15	20	1389	776	2165	143	144.5	88.5
VS 65/10		18.5	25	1503	841.5	2344.5	143	144.5	98
VS 65/11		18.5	25	1617	841.5	2458.5	143	144.5	100.5
VS 65/12		22	30	1730.5	906.5	2637	143	144.5	109
VS 65/13		22	30	1844.5	906.5	2751	143	144.5	112
VS 65/14		30	40	1958.5	1036.5	2995	143	144.5	129
VS 65/15		30	40	2072.5	1036.5	3109	143	144.5	131.5
VS 65/16		30	40	2186	1036.5	3222.5	143	144.5	134
VS 65/17		30	40	2300	1036.5	3336.5	143	144.5	137
VS 65/18		37	50	2414	1421.5	3835.5	143	144.5	193.5
VS 65/19		37	50	2527.5	1421.5	3949	143	144.5	196
VS 65/20		37	50	2641.5	1421.5	4063	143	144.5	198.5
VS 65/21		37	50	2755	1421.5	4176.5	143	144.5	201.5
VS 65/22		45	60	2869	1574	4443	143	144.5	218
VS 65/23		45	60	2983	1574	4557	143	144.5	220.5
VS 65/24		45	60	3096.5	1574	4670.5	143	144.5	223
VS 65/25		45	60	3210.5	1574	4784.5	143	144.5	225.5
VS 65/26		45	60	3324	1574	4898	143	144.5	228.5

PUMPS WITH REWINDABLE MOTOR

Pump model	Vers. R	Motor			Dimensions					Pump weight [Kg]
		Type	[kW]	[HP]	L1 [mm]	L2 [mm]	Lt [mm]	D [mm]		
								1 cable	2 cable	
VS 65/2	●	RW6	4	5.5	591.5	699	1290.5	147	147.5	61.5
VS 65/3	●		5.5	7.5	705.5	699	1404.5	147	147.5	64
VS 65/4	●		7.5	10	819.5	719	1538.5	147	147.5	69
VS 65/5	●		9.3	12.5	933.5	749	1682.5	147	147.5	74.5
VS 65/6	●		11	15	1047	779	1826	147	147.5	80
VS 65/7	●		13	17.5	1161	829	1990	147	147.5	87.5
VS 65/8	●		15	20	1275	874	2149	147	147.5	95.5
VS 65/9	●		15	20	1389	874	2263	147	147.5	98
VS 65/10	●		18.5	25	1503	919	2422	147	147.5	104.5
VS 65/11	●		18.5	25	1617	919	2536	147	147.5	107
VS 65/12	●		22	30	1730.5	1009	2739.5	147	147.5	118.5
VS 65/13	●		22	30	1844.5	1009	2853.5	147	147.5	121.5
VS 65/14	●		26	35	1958.5	1114	3072.5	147	147.5	135
VS 65/15	●		26	35	2072.5	1114	3186.5	147	147.5	137.5
VS 65/16	●		30	40	2186	1214	3400	147	147.5	150
VS 65/17	●		30	40	2300	1214	3514	147	147.5	153
VS 65/18	●		37	50	2414	1294	3708	147	147.5	162.5
VS 65/19	●		37	50	2527.5	1294	3821.5	147	147.5	165
VS 65/20	●		37	50	2641.5	1294	3935.5	147	147.5	167.5
VS 65/21	●		37	50	2755	1294	4049	147	147.5	170.5
VS 65/22			RW8	45	60	2969	1230	4199	189	189
VS 65/23		45		60	3083	1230	4313	189	189	227.5
VS 65/24		45		60	3196.5	1230	4426.5	189	189	230
VS 65/25		45		60	3310.5	1230	4540.5	189	189	232.5
VS 65/26		45		60	3424	1230	4654	189	189	235

● = Pump available in R (AISI 904L) version

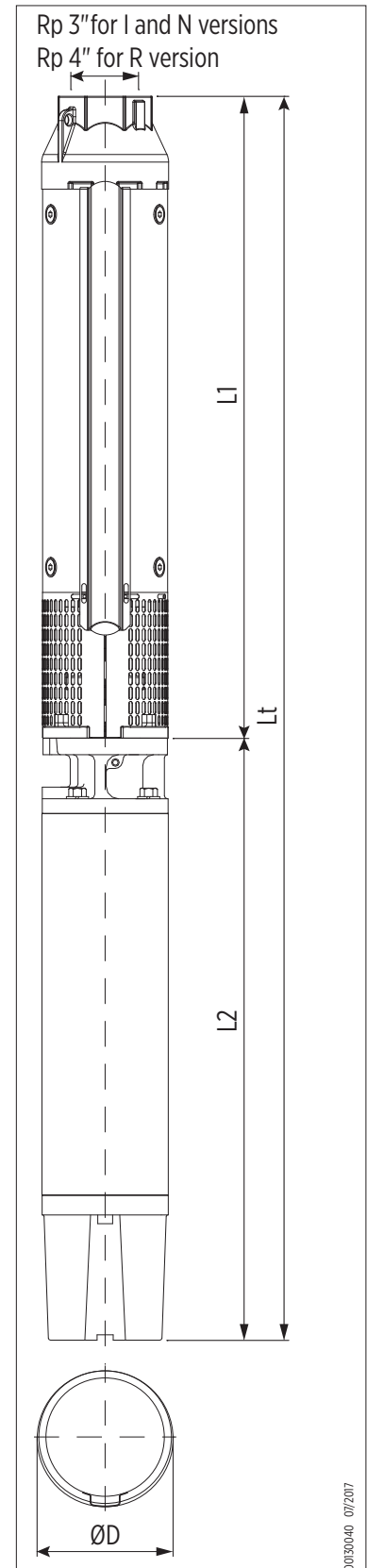

0030040 07/2017

VS 65 - PERFORMANCE CURVES AT 50 HZ

MEI ≥ 0,40

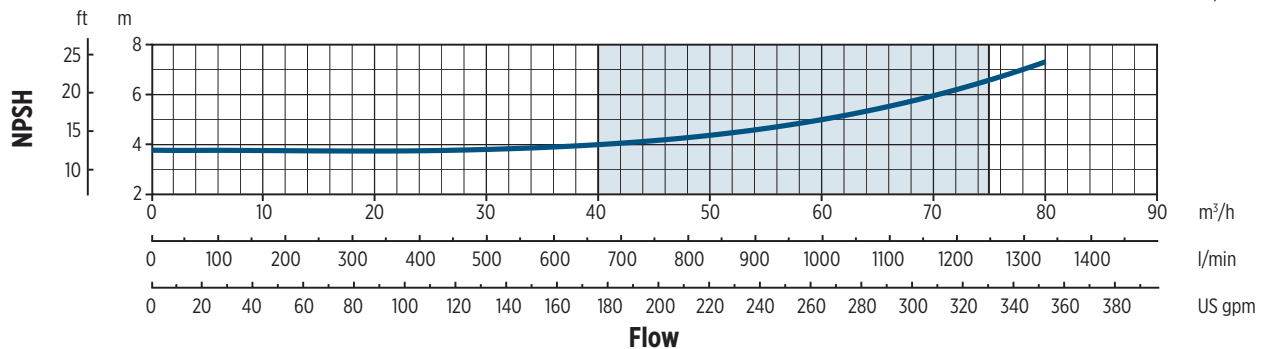
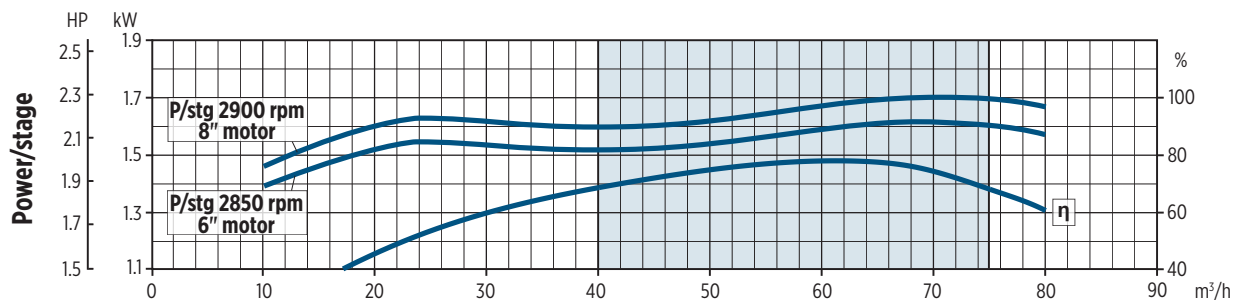
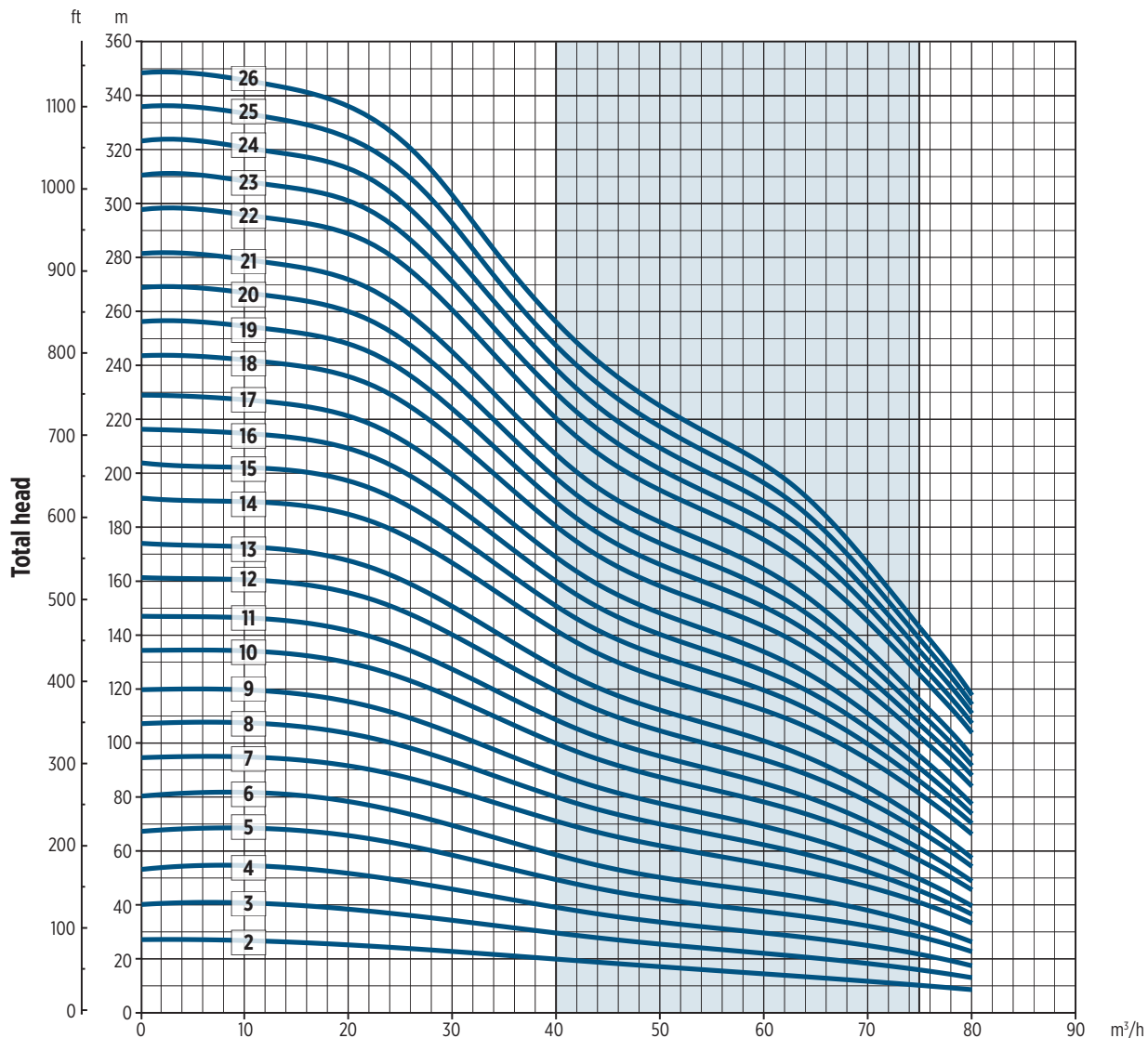

The hydraulic characteristics are guaranteed, according to ISO standard 9906:2012, grade 3B

VS 65 HIGH PRESSURE - TECHNICAL DATA

PUMPS WITH ENCAPSULATED MOTOR

Pump model	Motor			Dimensions					Pump weight [Kg]
	Type	[kW]	[HP]	L1 [mm]	L2 [mm]	Lt [mm]	D [mm]		
							1 cable	2 cable	
VS 65/27	E8	55	75	3538	1204	4742	190.5	190.5	261
VS 65/28		55	75	3652	1204	4856	190.5	190.5	263.5
VS 65/29		55	75	3765.5	1204	4969.5	190.5	190.5	266
VS 65/30		55	75	3879.5	1204	5083.5	190.5	190.5	268.5
VS 65/31		55	75	3993.5	1204	5197.5	190.5	190.5	271.5

PUMPS WITH REWINDABLE MOTOR

Pump model	Motor			Dimensions					Pump weight [Kg]
	Type	[kW]	[HP]	L1 [mm]	L2 [mm]	Lt [mm]	D [mm]		
							1 cable	2 cable	
VS 65/27	RW8	55	75	3538	1340	4878	189	189	265
VS 65/28		55	75	3652	1340	4992	189	189	267.5
VS 65/29		55	75	3765.5	1340	5105.5	189	189	270
VS 65/30		55	75	3879.5	1340	5219.5	189	189	272.5
VS 65/31		55	75	3993.5	1340	5333.5	189	189	275.5

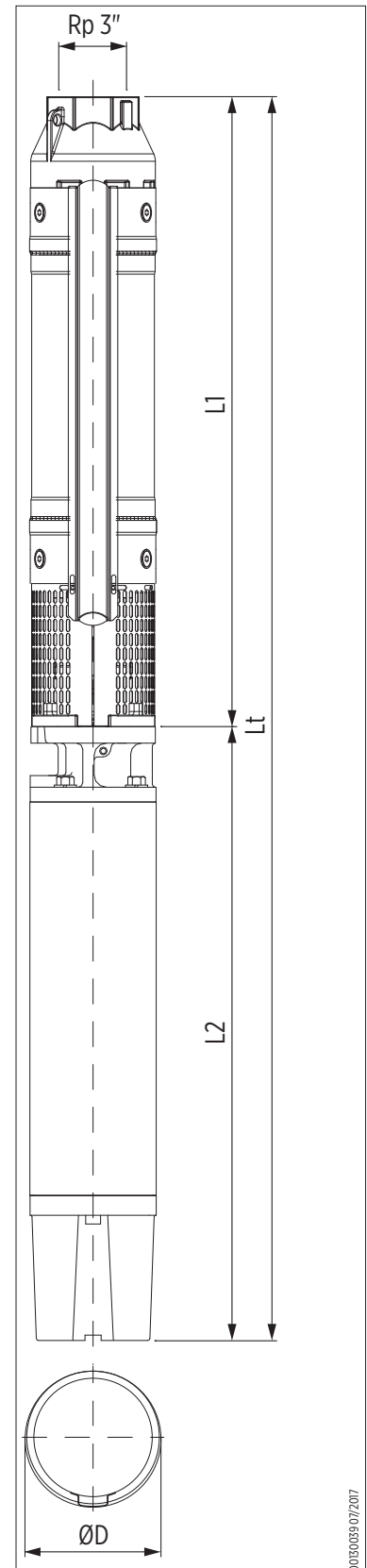

00103005907/2017

VS 65 HIGH PRESSURE - PERFORMANCE CURVES AT 50 HZ

MEI ≥ 0,40

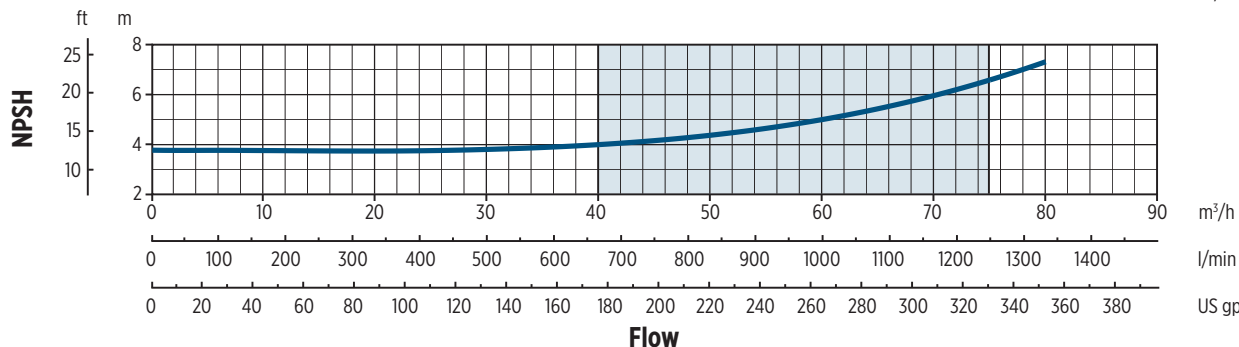
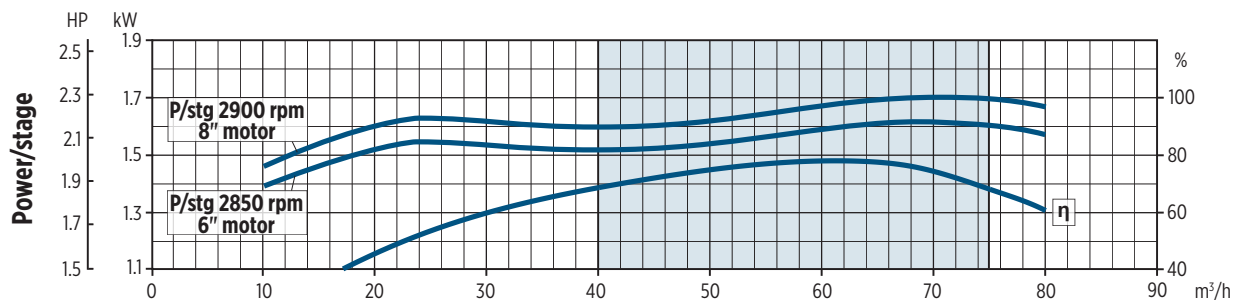
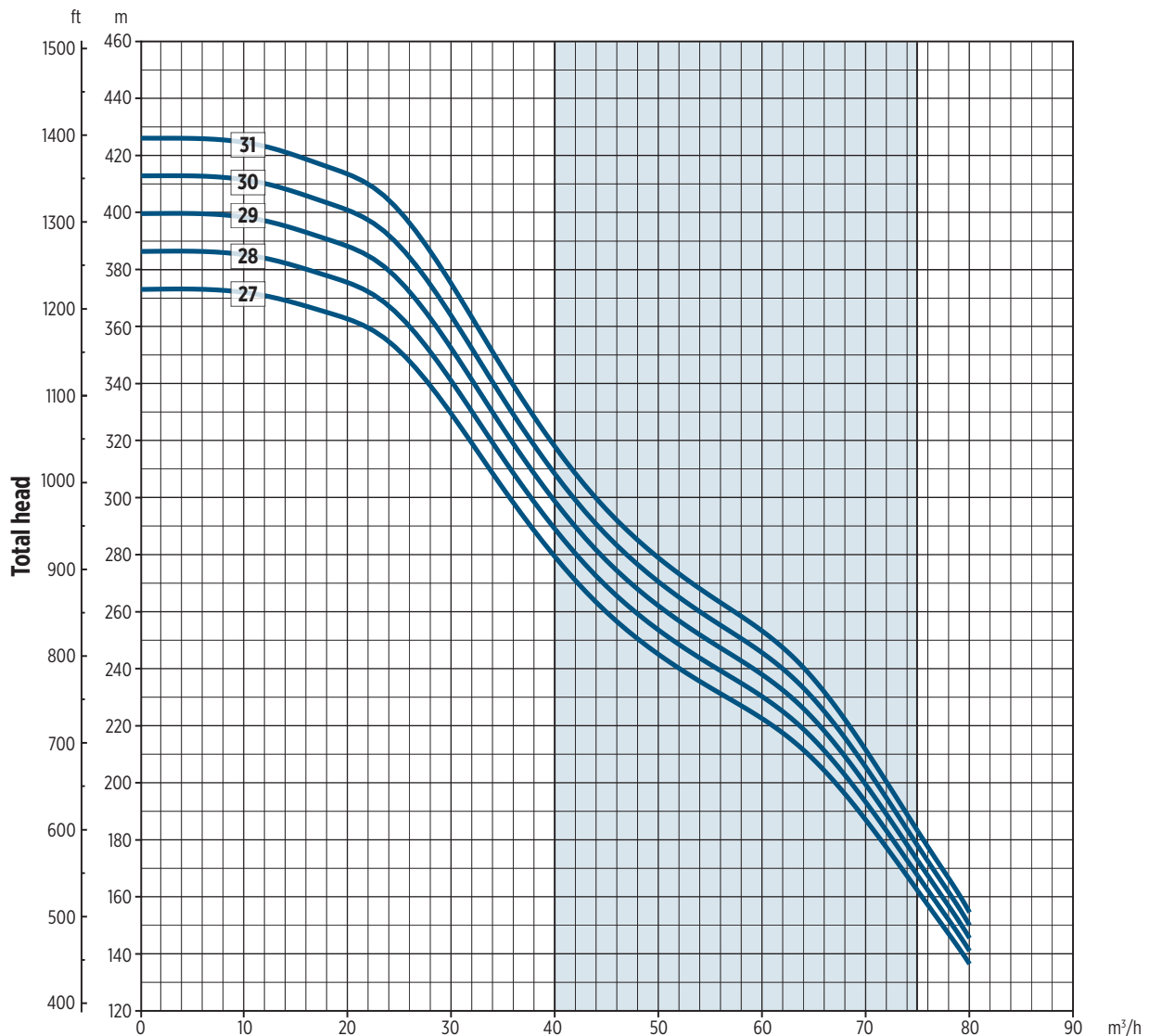

The hydraulic characteristics are guaranteed, according to ISO standard 9906:2012, grade 3B

SPARE PARTS

VS 14-19-25*

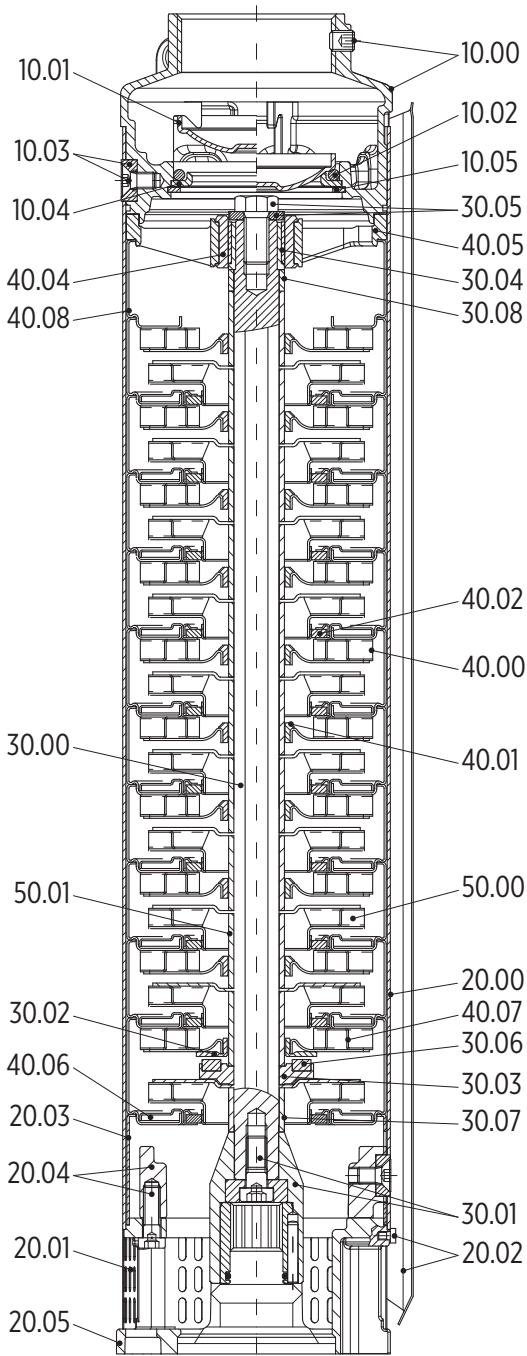

00130041EN 08/2017

Ref. N.	Description
10.00	Discharge head
10.01 10.04 10.05	Valve
10.02	Sealing O-ring
10.03	Outer case locking nuts
20.00	Outer case
20.01	Suction strainer
20.02	Cable guard and screws
20.03	Initial spacer
20.04	Flange
20.05	Screws
20.05	Motor adapter
20.06	4" motor flange
20.06	4" coupling adapter
30.00	Pump shaft
30.01	Coupling
30.02	Upper up-thrust washer
30.03	Lower up-thrust washer
30.04	Upper journal sleeve
30.05	Screw and washer
30.06	Up-thrust ring
30.07 30.08	Lower / Upper spacer
40.00	Diffuser
40.01	Secondary bearing bush
40.02	Floating neck ring
40.04	Bearing bush
40.05	Upper bearing guide
40.06	First diffuser
40.07	Diffuser with upper up-thrust washer
40.08	Last diffuser
50.00	Impeller
50.01	Impeller spacer

MOTOR ADAPTER 6x4

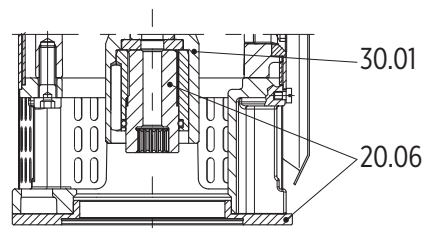

00130041EN 08/2017

* IMPORTANT: VS25 models only for sales out of EU or as a component of fire-fighting units

VS 30-46-65

Ref. N.	Description
10.00	Discharge head
10.01	Valve
10.04	
10.05	
10.02	Sealing O-ring
10.03	Outer case locking nuts
20.00	Outer case
20.01	Suction strainer
20.02	Cable guard and screws
20.03	Initial spacer
20.04	Flange
20.05	Screws
20.06	Motor adapter
20.07	8" motor adapter
30.00	Pump shaft

Ref. N.	Description
30.01	Coupling
30.03	Lower up-thrust washer
30.04	Upper journal sleeve
30.05	Screw and washer
30.06	Up-thrust ring
40.00	Diffuser
40.01	Secondary bearing bush
40.02	Floating neck ring
40.03	Flange clamping neck ring
40.04	Bearing bush
40.05	Last - Intermediate diffuser
50.00	Wear ring
50.05	Impeller
51.01	Split cone
51.02	Split cone nut
51.03	Intermediate cone nut
51.04	Up-thrust split cone nut
51.06	Intermediate impeller with screw

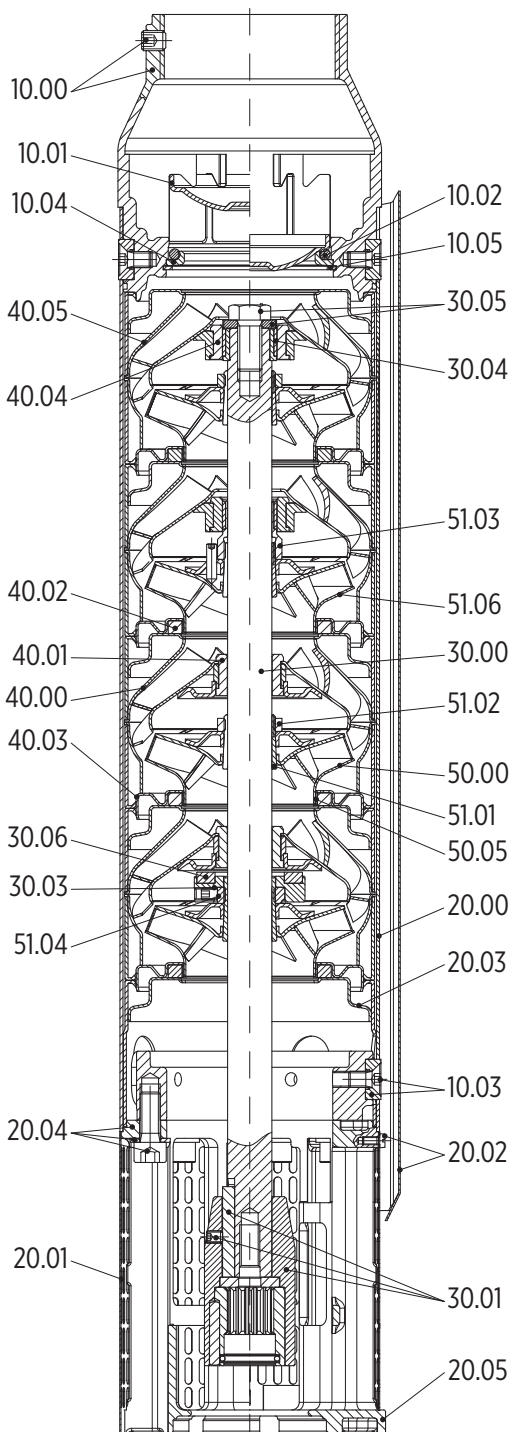

MOTOR ADAPTER 6x4

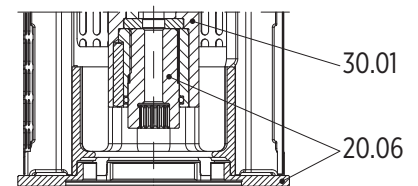

MOTOR ADAPTER 6x8

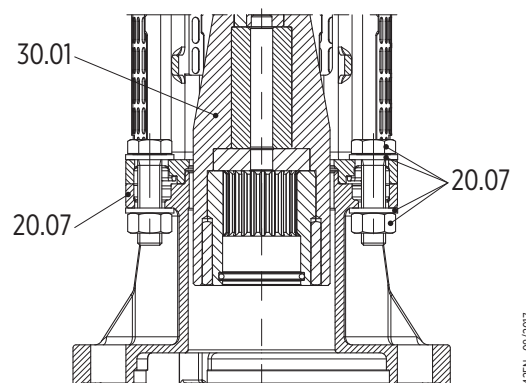

0035004ZEN 08/2017

0035004ZEN 08/2017

MOTOR ADAPTER AND DIMENSIONS

VS 14-19-25*

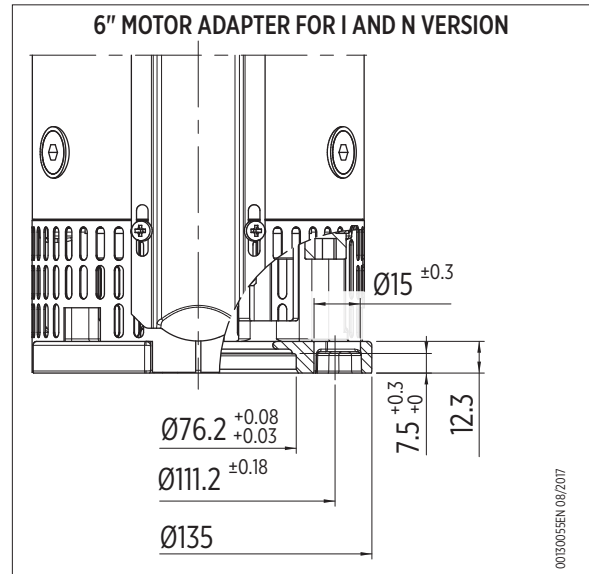
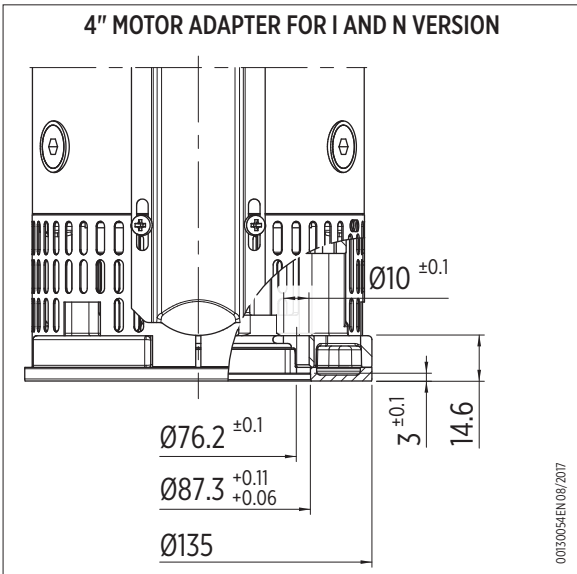

* IMPORTANT: VS25 models only for sales out of EU or as a component of fire-fighting units

VS 30-46-65

4" MOTOR ADAPTER FOR I AND N VERSION

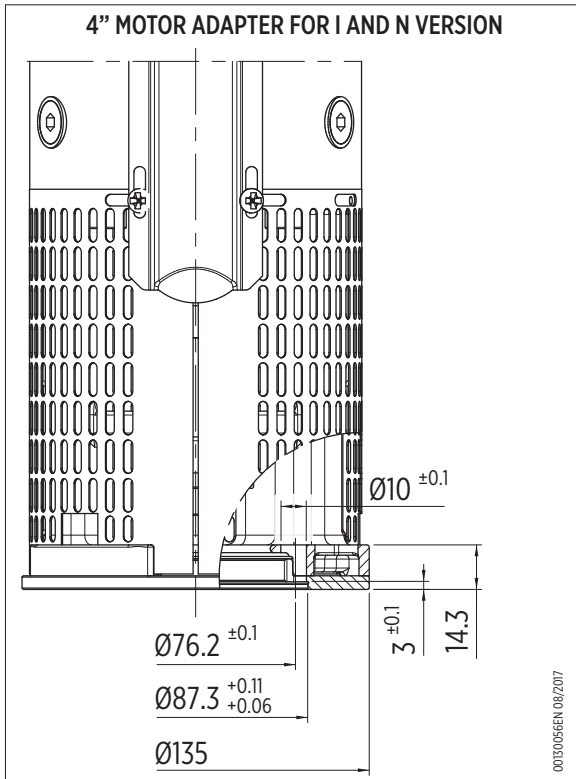

6" MOTOR ADAPTER FOR I, N AND R VERSION

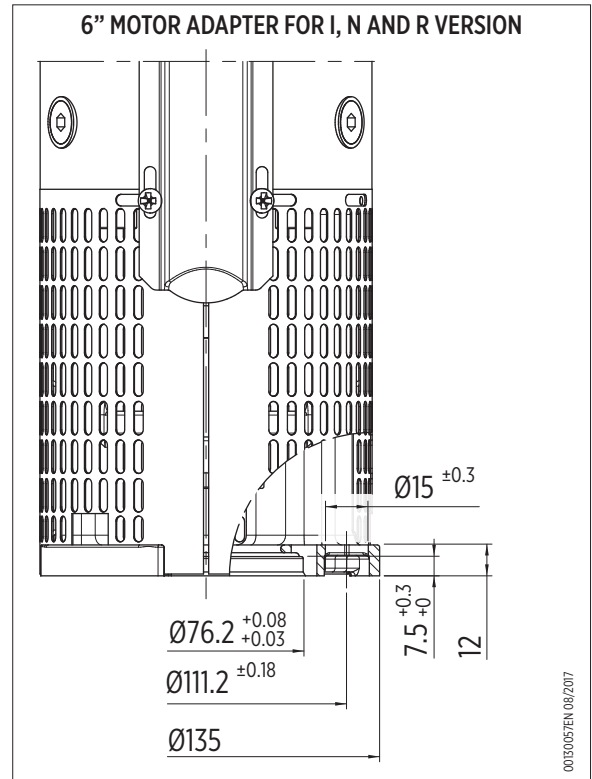

8" MOTOR ADAPTER FOR I AND N VERSION

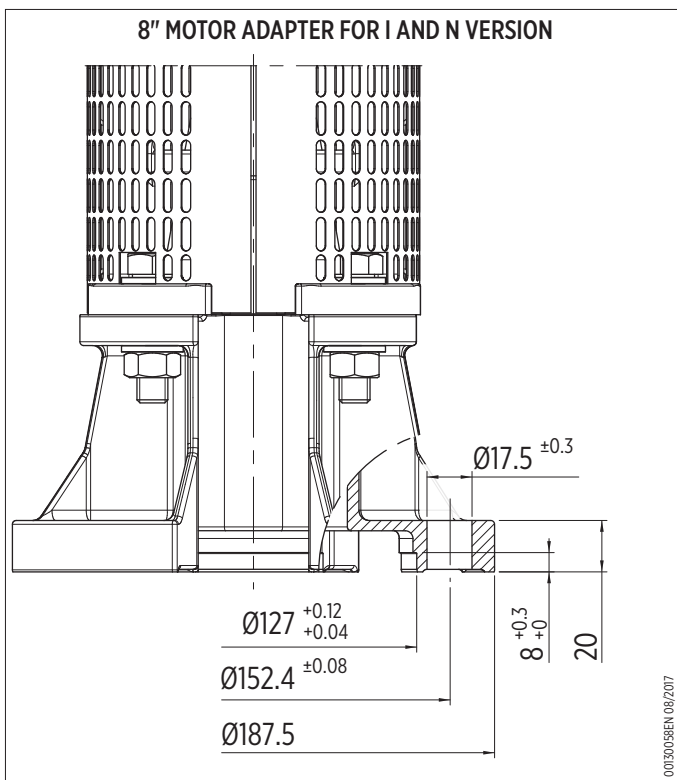



VS 8" Series

50 Hz

VS 78 - 97

8" STAINLESS STEEL SUBMERSIBLE PUMPS

APPLICATION

- Municipal water works
- Water distribution and pressure boosting
- Irrigation and sprinkler systems, water treatment plants, filtration and reverse osmosis
- Industrial cooling and processing
- Mining industry, drainage and dewatering
- Fire-fighting equipment
- Fountains

FEATURES

- Stainless steel components for durability and robustness, guaranteeing longevity and trouble-free operation. Many design technical features make this pump range very compact and extremely reliable, to ensure applications in the most complex and severe conditions.
- External stainless steel sleeve to improve stiffness and assure permanent alignment of all the components
- Motor adapter and discharge head may be removed without disturbing the impeller / diffuser stack
- Built-in check valve and over size pump shaft
- Easy maintenance without the need of special tools

PUMP SPECIFICATION

- Flow: up to 120 m³/h at 50 Hz
- Head: up to 500 m (50 Bar) at 50 Hz
- Water temperature range:
 - Minimum: -5 °C
 - Maximum: +90 °C (+60 °C for NBR parts)
- Maximum allowable amount of sand 100 g/m³
- Rotation: counter clockwise when looking into the discharge
- Pump can work continuously in vertical or horizontal position

MOTOR SPECIFICATION

- Motor adapter in compliance with NEMA standard
- For more information consult the product catalog of Submersible motors

AVAILABLE ON REQUEST

- Pump material:
 - 316 Stainless steel (N) version (DIN/EN 1.4401)
 - 904L (R) version (DIN/EN 1.4539)
 - See specified material variant in Materials/fluids compatibility table on page 50
- Double cable guard
- Discharge head:
 - Rp 4" for I and N versions
 - Rp 6" for R version
- Pump with NBR rubber parts

FAMILY CURVES

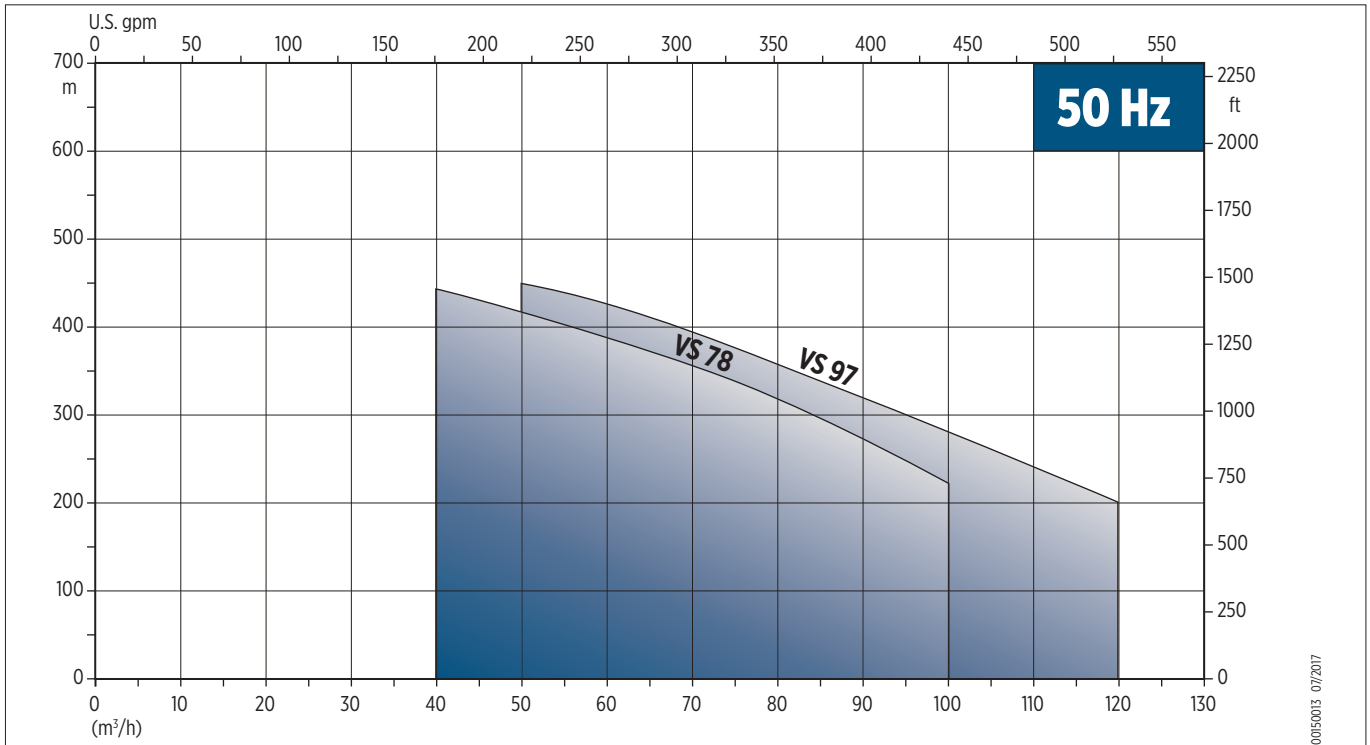

00150015 07/2017

PUMP IDENTIFICATION CODE

VS 78 / 15 I M8 RP5 E1 P HP SD

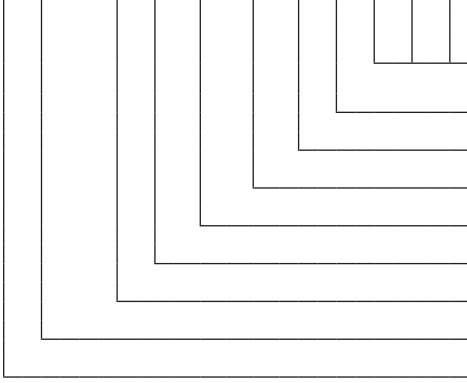

- Pump speciality: P (Passivated); HP (High pressure); SD (Double cable guard)
- Bearing bush material: E1 (EPDM)
- Frequency: 50 (50 Hz); 60 (60 Hz)
- Discharge head (threaded type and dimension): Rp(X); NPT(X)
- Motor coupling dimension: M8 (8")
- Material: I (AISI 304); N (AISI 316); R (AISI 904L)
- Number of stages
- Nominal flow in m³/h
- Pump model

001400106/2021

PUMPS AND MOTORS RANGE

Type	Versions			Motor power range [kW]	
	I EN 1.4301	N EN 1.4401	R EN 1.4539	I e N	R
	VS78	○	○	●	7.5 ÷ 93
VS97	○	○	●	9.3 ÷ 110	30 ÷ 93

○ = Version available ● = Version available only with 6" motor coupling

MATERIALS/FLUIDS COMPATIBILITY

Ref. No.	Parts description	Material	Standard					
			I Version		N Version		R Version	
			ASTM	DIN/EN	ASTM	DIN/EN	ASTM	DIN/EN
10.00	Discharge head	Stainless steel	CF8 (304)	1.4308	CF8M (316)	1.4408	CD4MCuN (904L)	1.4517
10.01	Valve	Stainless steel	316	1.4401	316	1.4401	2205/904L	1.4462/1.4460
10.02	Sealing O-ring	EPDM						
10.03	Outer case locking nuts	Stainless steel	316	1.4401	316	1.4401	2205	1.4462
10.04	Valve support	Stainless steel and PTFE	316	1.4401	316	1.4401	904L	1.4539
10.05	Seeger ring	Stainless steel	316	1.4401	316	1.4401	904L	1.4539
20.00	Outer case	Stainless steel	304	1.4301	316	1.4401	2205	1.4462
20.01	Suction strainer	Stainless steel	316	1.4401	316	1.4401	904L	1.4539
20.02	Cable guard and screws	Stainless steel	316	1.4401	316	1.4401	904L	1.4539
20.03	Initial spacer	Stainless steel	316	1.4401	316	1.4401	904L	1.4539
20.04	Flange	Stainless steel	CF8 (304)	1.4308	CF8M (316)	1.4408	CD4MCuN (904L)	1.4517
	Screws		304	1.4301	316	1.4401	904L	1.4539
20.05	Motor adapter	Stainless steel	CF8 (304)	1.4308	CF8M (316)	1.4408	CD4MCuN (904L)	1.4517
30.00	Pump shaft	Stainless steel	329	1.4460	329	1.4460	329	1.4460
30.01	Coupling	Stainless steel	431/329	1.4057/1.4460	316/329	1.4401/1.4460	2205/904L	1.4462/1.4539
30.02	Upper up-thrustwasher	Stainless steel	329	1.4460	329	1.4460	329	1.4460
30.03	Lower up-thrust washer	Stainless steel	329	1.4460	329	1.4460	329	1.4460
30.04	Upper journal sleeve ⁽¹⁾	Alluminum Oxide (Alumina)	Al2 O3 (99,7%)					
30.05	Screw and washer ⁽¹⁾	Stainless steel	316	1.4401	316	1.4401	904L/329	1.4539/1.4460
30.06	Up-thrust ring	PTFE + Graphite						
40.00	Diffuser	Stainless steel	304	1.4301	316	1.4401	904L	1.4539
40.01	Secondary bearing bush	EPDM						
40.02	Floating neck ring	PTFE						
40.03	Flange clamping neck ring	Stainless steel	316	1.4401	316	1.4401	904L	1.4539
50.00	Impeller	Stainless steel	316	1.4401	316	1.4401	904L	1.4539
51.01	Split cone	Stainless steel	316	1.4401	316	1.4401	329	1.4460
51.02	Split cone nut	Stainless steel	316	1.4401	316	1.4401	329	1.4460

1) Only for models with more that 8 stages

HYDRAULIC PERFORMANCE AT 50 HZ

VS 78

Pump model	R Vers.	RATED POWER		Q = DELIVERY								
				m ³ /h 0	30	40	50	60	70	80	90	100
		[kW]	[HP]	l/min 0	500	666	833	1000	1166	1333	1500	1666
H = TOTAL HEAD METERS COLUMN OF WATER [m]												
VS 78/2	●	7.5	10	40	38	35	32	30	29	24	20	18
VS 78/3	●	11	15	60	55	51	49	45	41	36	30	24
VS 78/4	●	15	20	80	74	70	65	60	55	49	41	32
VS 78/5	●	18.5	25	99	92	88	81	75	69	60	51	41
VS 78/6	●	22	30	119	110	104	98	89	81	71	60	49
VS 78/7	●	30	40	139	130	122	114	105	96	85	72	58
VS 78/8	●	30	40	159	149	140	131	120	110	98	82	67
VS 78/9	●	30	40	180	168	158	147	135	123	110	92	73
VS 78/10	●	37	50	197	183	172	160	148	134	119	100	79
VS 78/11	●	37	50	216	202	190	176	162	148	130	110	87
VS 78/12	●	45	60	248	232	219	205	189	172	153	131	106
VS 78/13	●	55	75	269	252	237	221	205	188	168	142	115
VS 78/14	●	55	75	289	271	256	239	220	201	180	153	123
VS 78/15	●	55	75	309	290	274	255	235	215	192	165	132
VS 78/16	●	75	100	332	311	294	275	252	231	208	177	143
VS 78/17	●	75	100	352	330	312	291	269	246	220	188	151
VS 78/18	●	75	100	373	350	330	309	284	260	232	198	161
VS 78/19	●	75	100	394	370	348	325	300	275	245	210	170
VS 78/20	●	75	100	415	389	368	343	316	290	259	220	179
VS 78/21	●	75	100	436	409	385	360	331	304	271	231	189
VS 78/22	●	93	125	457	428	404	378	347	320	284	243	198
VS 78/23	●	93	125	478	446	421	394	362	332	297	254	207
VS 78/24	●	93	125	498	467	440	411	379	348	310	265	216

● = Pump available in R (AISI 904L) version

VS 97

Pump model	R Vers.	RATED POWER		Q = DELIVERY										
				m ³ /h 0	30	40	50	60	70	80	90	100	110	120
		[kW]	[HP]	l/min 0	500	666	833	1000	1166	1333	1500	1666	1833	2000
H = TOTAL HEAD METERS COLUMN OF WATER [m]														
VS 97/2	●	9.3	12.5	42	41	39	36	32	30	29	26	22	19	15
VS 97/3	●	15	20	63	60	58	53	49	45	42	39	33	29	21
VS 97/4	●	18.5	25	84	81	77	71	65	60	57	51	45	38	30
VS 97/5	●	22	30	104	101	95	88	80	74	69.5	62	55	46	37
VS 97/6	●	30	40	127	122	115	107	98	90	84	77	68	57	46
VS 97/7	●	30	40	148	143	135	123	115	106	99	90	79	68	52
VS 97/8	●	37	50	168	160	151	140	130	120	110	100	88.5	74	59
VS 97/9	●	37	50	188	180	170	158	147	133	124	113	99	83	66
VS 97/10	●	45	60	219	211	200	185	172	159	148	137	120	103	82
VS 97/11	●	55	75	241	232	220	204	189	175	162	149	132	113	91
VS 97/12	●	55	75	262	253	240	221	207	191	178	162	143	123	99
VS 97/13	●	55	75	284	275	260	241	223	207	191	177	155	132	108
VS 97/14	●	75	100	309	297	282	261	242	226	209	191	169	145	121
VS 97/15	●	75	100	330	319	303	280	260	240	222	205	181	155	130
VS 97/16	●	75	100	352	340	322	299	279	258	238	220	194	165	139
VS 97/17	●	75	100	373	361	342	319	294	272	252	232	207	176	147
VS 97/18	●	93	125	398	382	363	337	313	289	268	247	219	188	155
VS 97/19	●	93	125	419	403	382	354	330	305	282	260	230	197	164
VS 97/20	●	93	125	440	423	404	372	347	320	298	273	241	208	171
VS 97/21	●	93	125	462	445	422	391	363	337	312	289	255	219	171
VS 97/22		110	150	484	466	442	410	381	353	328	301	267	229	190
VS 97/23		110	150	507	487	463	430	399	370	341	315	279	239	199

● = Pump available in R (AISI 904L) version

VS 78 - TECHNICAL DATA

PUMPS WITH ENCAPSULATED MOTOR

Pump model	Motor			Dimensions					Pump weight [Kg]
	Type	[kW]	[HP]	L1 [mm]	L2 [mm]	Lt [mm]	D [mm]		
							1 cable	2 cable	
VS 78/2	E6	7.5	10	644	646	1290	188	194	77
VS 78/3		11	15	770	711	1481	188	194	87
VS 78/4		15	20	896	776	1672	188	194	57
VS 78/5		18.5	25	1022	841.5	1863.5	188	194	109
VS 78/6		22	30	1148	906.5	2054.5	188	194	120
VS 78/7		30	40	1274	1036.5	2310.5	188	194	140
VS 78/8		30	40	1400	1036.5	2436.5	188	194	145
VS 78/9		30	40	1526	1036.5	2562.5	188	194	150
VS 78/10		37	50	1652	1405	3057	188	194	206
VS 78/11		37	50	1778	1405	3183	188	194	211
VS 78/12		E8	45	60	1909	1077	2986	200	202
VS 78/13	55		75	2035	1394	3429	200	202	259
VS 78/14	55		75	2161	1394	3555	200	202	294
VS 78/15	55		75	2287	1394	3681	200	202	299
VS 78/16	75		100	2413	1496	3909	200	202	342
VS 78/17	75		100	2539	1496	4035	200	202	347
VS 78/18	75		100	2665	1496	4161	200	202	352
VS 78/19	75		100	2791	1496	4287	200	202	357
VS 78/20	75		100	2917	1496	4413	200	202	361
VS 78/21	75		100	3043	1496	4539	200	202	366
VS 78/22	93		125	3169	1748	4917	200	202	449
VS 78/23	93		125	3295	1748	5043	200	202	454
VS 78/24	93		125	3421	1748	5169	200	202	459

PUMPS WITH REWINDABLE MOTOR

Pump model	R vers.	Motor			Dimensions					Pump weight [Kg]
		Type	[kW]	[HP]	L1 [mm]	L2 [mm]	Lt [mm]	D [mm]		
								1 cable	2 cable	
VS 78/2	●	RW6	7.5	10	644	719	1363	188	194	82
VS 78/3	●		11	15	770	779	1549	188	194	92
VS 78/4	●		15	20	896	874	1770	188	194	96
VS 78/5	●	RW8	18.5	25	1022	919	1941	188	194	116
	●		30	40	1022	1140	2162	197	199.5	190
VS 78/6	●	RW6	22	30	1148	1009	2157	188	194	130
	●	RW8	30	40	1148	1140	2288	197	199.5	193
VS 78/7	●	RW6	26	35	1274	1114	2388	188	194	146
	●	RW8	30	40	1274	1140	2288	197	199.5	198
VS 78/8	●	RW6	30	40	1400	1214	2614	188	194	161
	●	RW8	30	40	1400	1140	2540	197	199.5	203
VS 78/9	●	RW6	30	40	1526	1214	2740	188	194	166
	●	RW8	30	40	1526	1140	2666	197	199.5	208
VS 78/10	●	RW6	37	50	1652	1294	2946	188	194	178
	●	RW8	37	50	1652	1140	2792	197	199.5	213
VS 78/11	●	RW6	37	50	1778	1294	3072	188	194	183
	●		37	50	1778	1140	2918	197	199.5	218
VS 78/12	●	RW8	45	60	1909	1230	3139	197	199.5	238
VS 78/13	●		52	70	2035	1340	3375	197	199.5	266
VS 78/14	●		52	70	2161	1340	3501	197	199.5	271
VS 78/15	●		55	75	2287	1340	3627	197	199.5	276
VS 78/16	●		60	80	2413	1470	3883	197	199.5	300
VS 78/17	●		67	90	2539	1470	4009	197	199.5	305
VS 78/18	●		67	90	2665	1470	4135	197	199.5	310
VS 78/19	●		75	90	2791	1560	4351	197	199.5	332
VS 78/20	●		75	100	2917	1560	4477	197	199.5	336
VS 78/21	●		75	100	3043	1560	4603	197	199.5	341
VS 78/22	●		83	110	3169	1560	4729	197	199.5	378
VS 78/23	●		83	110	3295	1560	4855	197	199.5	383
VS 78/24	●		93	125	3421	1740	5161	197	199.5	388

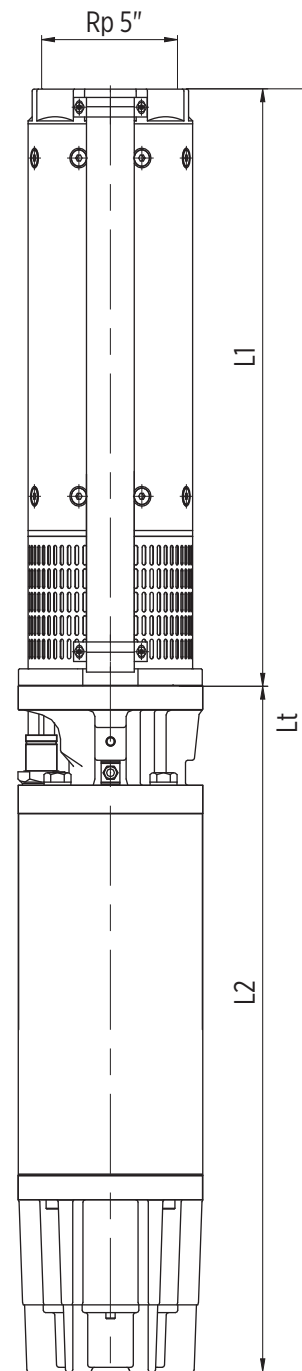

● = Pump available in R (AISI 904L) version

00730060_09/2017

VS 78 - PERFORMANCE CURVES AT 50 HZ

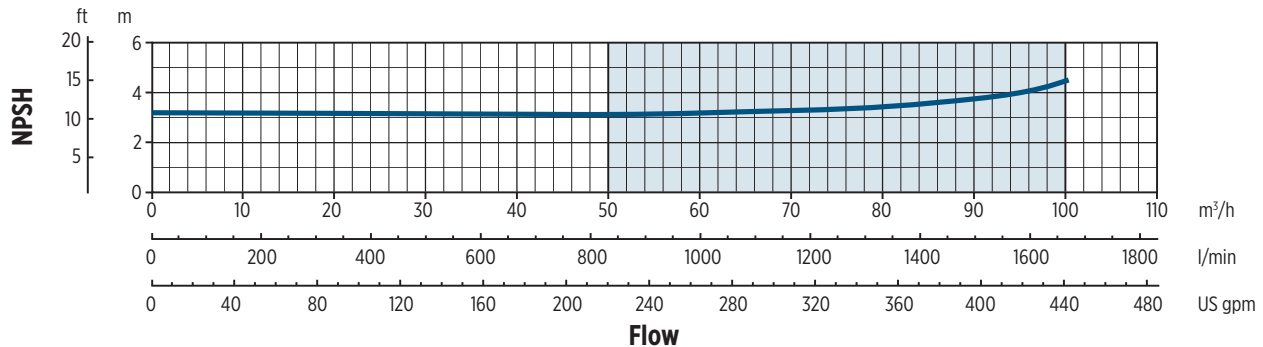
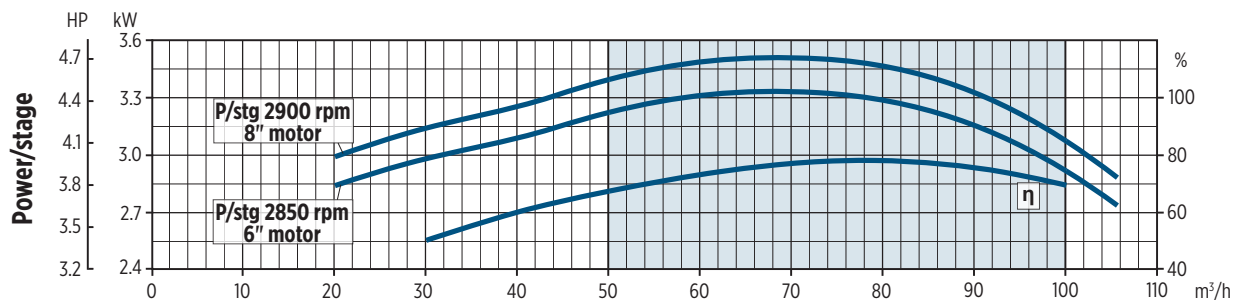
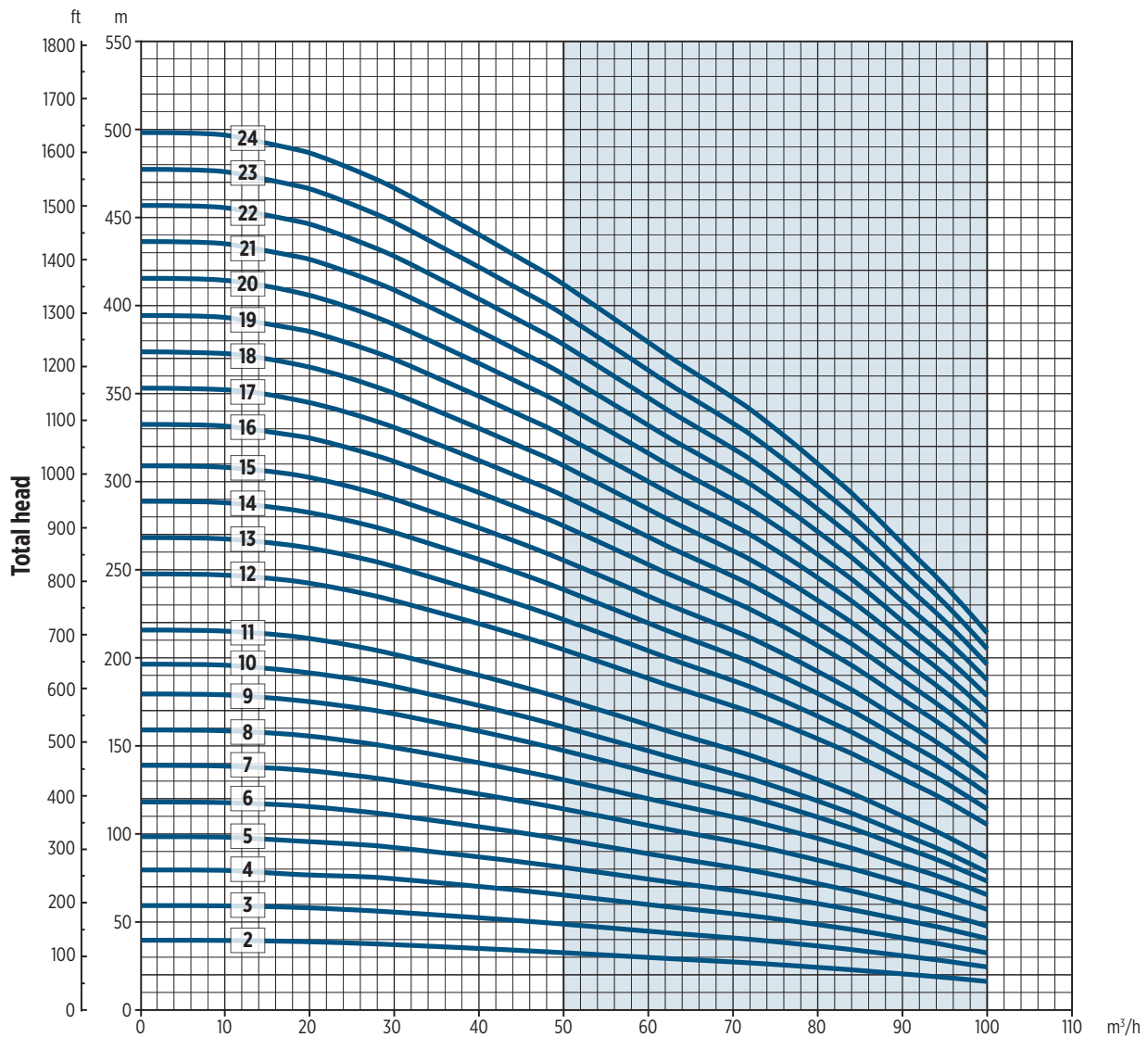

The hydraulic characteristics are guaranteed, according to ISO standard 9906:2012, grade 3B

VS 97 - TECHNICAL DATA

PUMPS WITH ENCAPSULATED MOTOR

Pump model	Motor			Dimensions					Pump weight [Kg]
	Type	[kW]	[HP]	L1 [mm]	L2 [mm]	Lt [mm]	D [mm]		
							1 cable	2 cable	
VS 97/2	E6	9.3	12.5	644	678.5	1322.5	188	194	79
VS 97/3		15	20	770	776	1546	188	194	93
VS 97/4		18.5	25	896	841.5	1737.5	188	194	105
VS 97/5		22	30	1022	906.5	1928.5	188	194	115.5
VS 97/6		30	40	1148	1036.5	2184.5	188	194	135
VS 97/7		30	40	1274	1036.5	2310.5	188	194	140
VS 97/8		37	50	1400	1405	2805	188	194	196
VS 97/9		37	50	1526	1405	2931	188	194	201
VS 97/10		E8	45	60	1657	1077	2734	200	202
VS 97/11	55		75	1783	1394	3177	200	202	279
VS 97/12	55		75	1909	1394	3303	200	202	284
VS 97/13	55		75	2035	1394	3429	200	202	289
VS 97/14	75		100	2161	1496	3657	200	202	332
VS 97/15	75		100	2287	1496	3783	200	202	337
VS 97/16	75		100	2413	1496	3909	200	202	342
VS 97/17	75		100	2539	1496	4035	200	202	346.5
VS 97/18	93		125	2665	1748	4413	200	202	429.5
VS 97/19	93		125	2791	1748	4539	200	202	434.5
VS 97/20	93		125	2917	1748	4665	200	202	439
VS 97/21	93		125	3043	1748	4791	200	202	444
VS 97/22	110		150	3169	1976	5145	200	202	512
VS 97/23	110		150	3295	1976	5271	200	202	517

PUMPS WITH REWINDABLE MOTOR

Pump model	R vers.	Motor			Dimensions					Pump weight [Kg]
		Type	[kW]	[HP]	L1 [mm]	L2 [mm]	Lt [mm]	D [mm]		
								1 cable	2 cable	
VS 97/2	●	RW6	9.3	12.5	644	749	1393	188	194	84.5
VS 97/3	●		13	17.5	770	829	1599	188	194	97.5
VS 97/4	●		18.5	25	896	919	1815	188	194	111.5
VS 97/5	●	RW8	22	30	1022	1009	2031	188	194	125
VS 97/6	●		30	40	1022	1140	2162	197	199.5	188
VS 97/7	●	RW6	26	35	1148	1114	2262	188	194	141
VS 97/8	●		30	40	1148	1140	2288	197	199.5	193
VS 97/9	●	RW8	30	40	1274	1214	2488	188	194	156
VS 97/10	●		30	40	1274	1140	2414	197	199.5	198
VS 97/11	●	RW6	37	50	1400	1294	2694	188	194	168
VS 97/12	●		37	50	1400	1140	2540	197	199.5	203
VS 97/13	●	RW8	37	50	1526	1294	2820	188	194	173
VS 97/14	●		37	50	1526	1140	2666	197	199.5	208
VS 97/15	●	RW6	45	70	1657	1230	2887	197	199.5	228
VS 97/16	●		52	70	1783	1340	3123	197	199.5	256
VS 97/17	●	RW8	52	75	1909	1340	3249	197	199.5	261
VS 97/18	●		55	90	2035	1340	3375	197	199.5	266
VS 97/19	●	RW6	67	90	2161	1470	3631	197	199.5	290
VS 97/20	●		67	90	2287	1470	3757	197	199.5	295
VS 97/21	●	RW8	75	100	2413	1560	3973	197	199.5	317
VS 97/22	●		75	100	2539	1560	4099	197	199.5	321.5
VS 97/23	●	RW6	83	110	2665	1560	4225	197	199.5	358.5
VS 97/24	●		83	110	2791	1560	4351	197	199.5	363.5
VS 97/25	●	RW8	93	125	2917	1740	4657	197	199.5	368
VS 97/26	●		93	125	3043	1740	4783	197	199.5	373

● = Pump available in R (AISI 904L) version

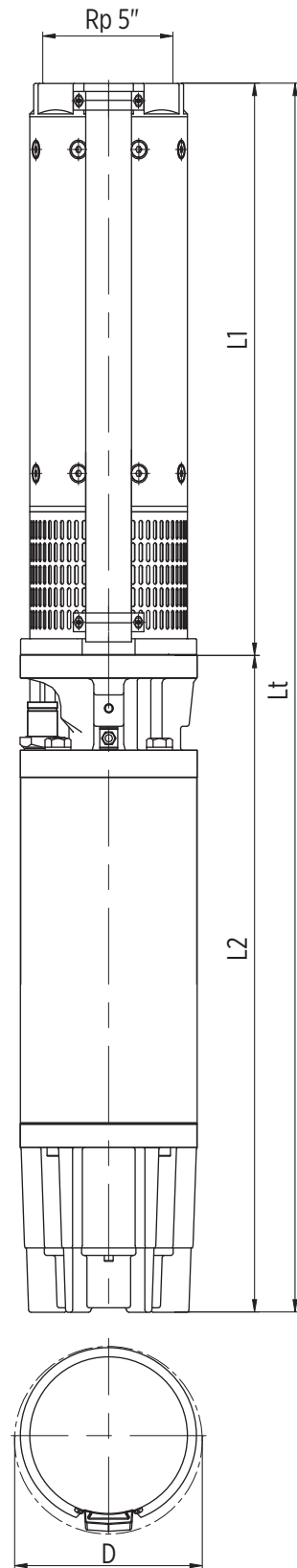

00730060 09/2017

VS 97 - PERFORMANCE CURVES AT 50 HZ

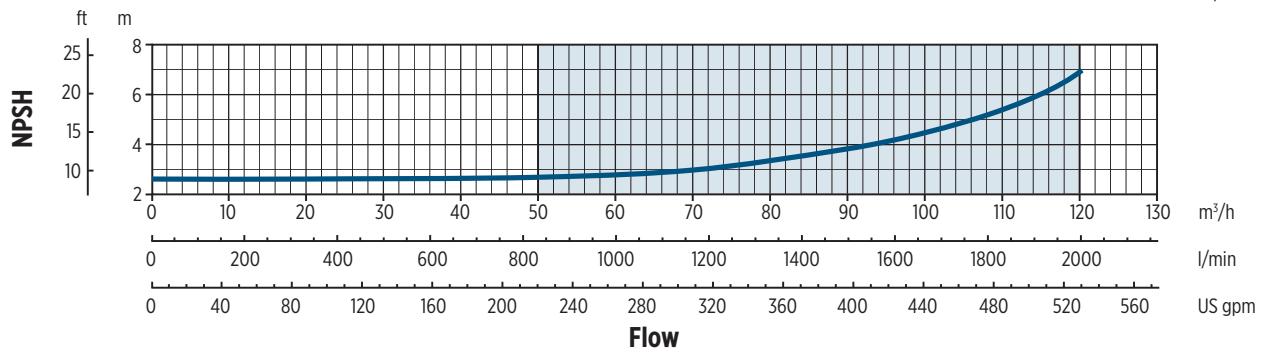
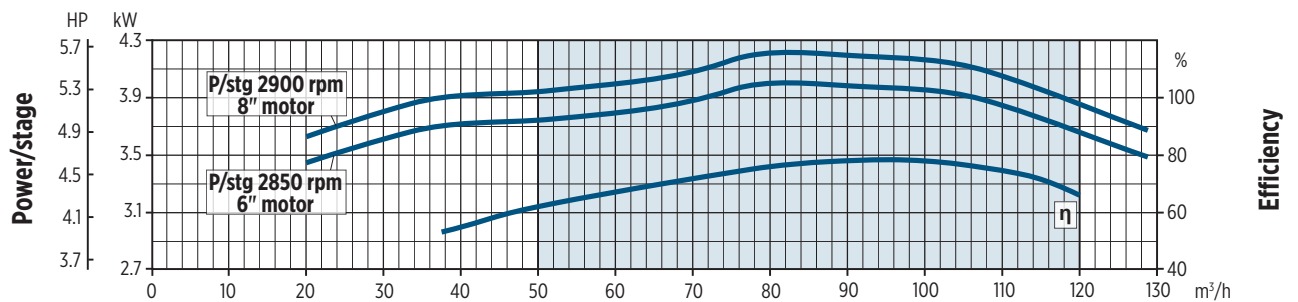
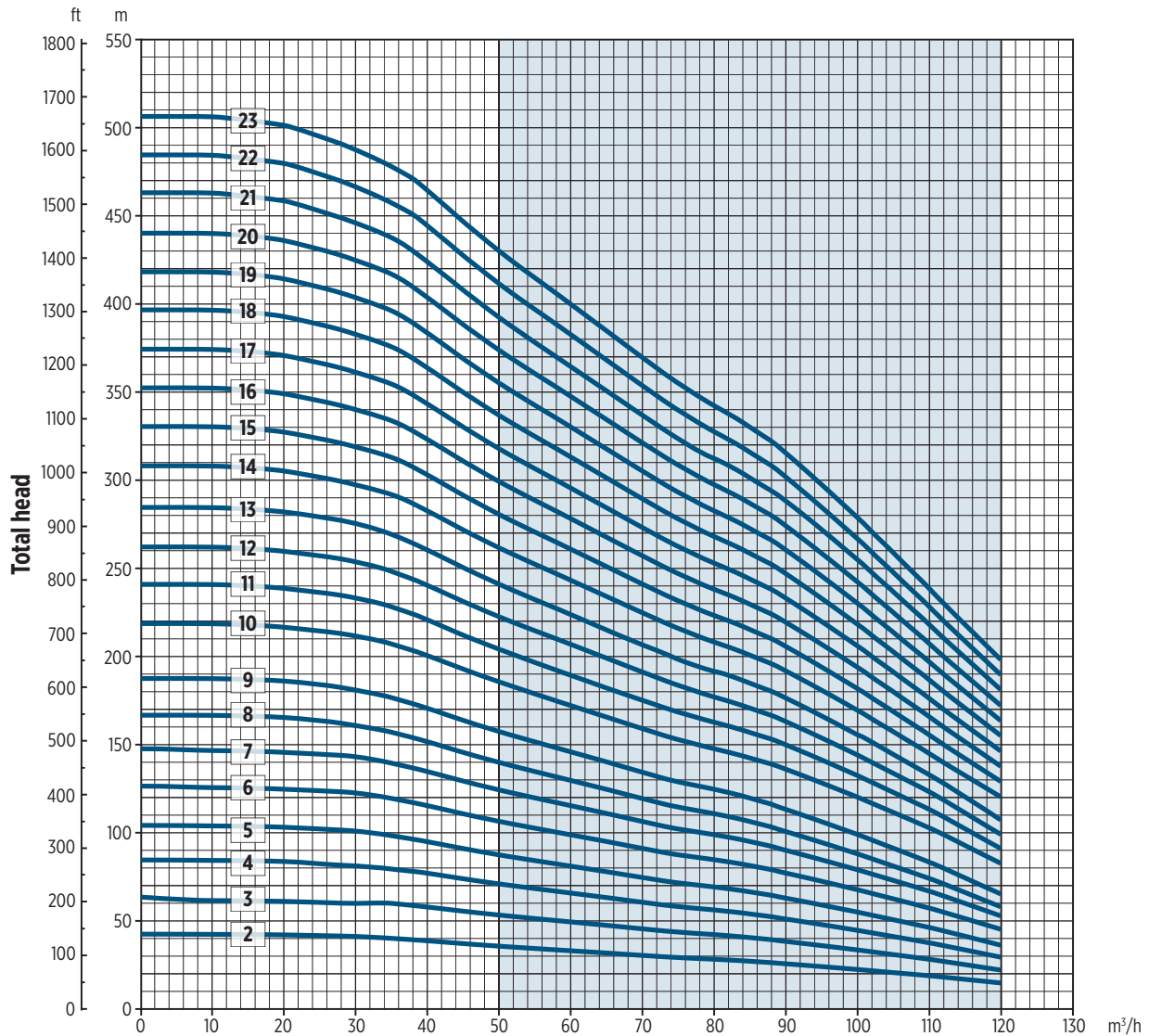

The hydraulic characteristics are guaranteed, according to ISO standard 9906:2012, grade 3B

SPARE PARTS

VS 78-97

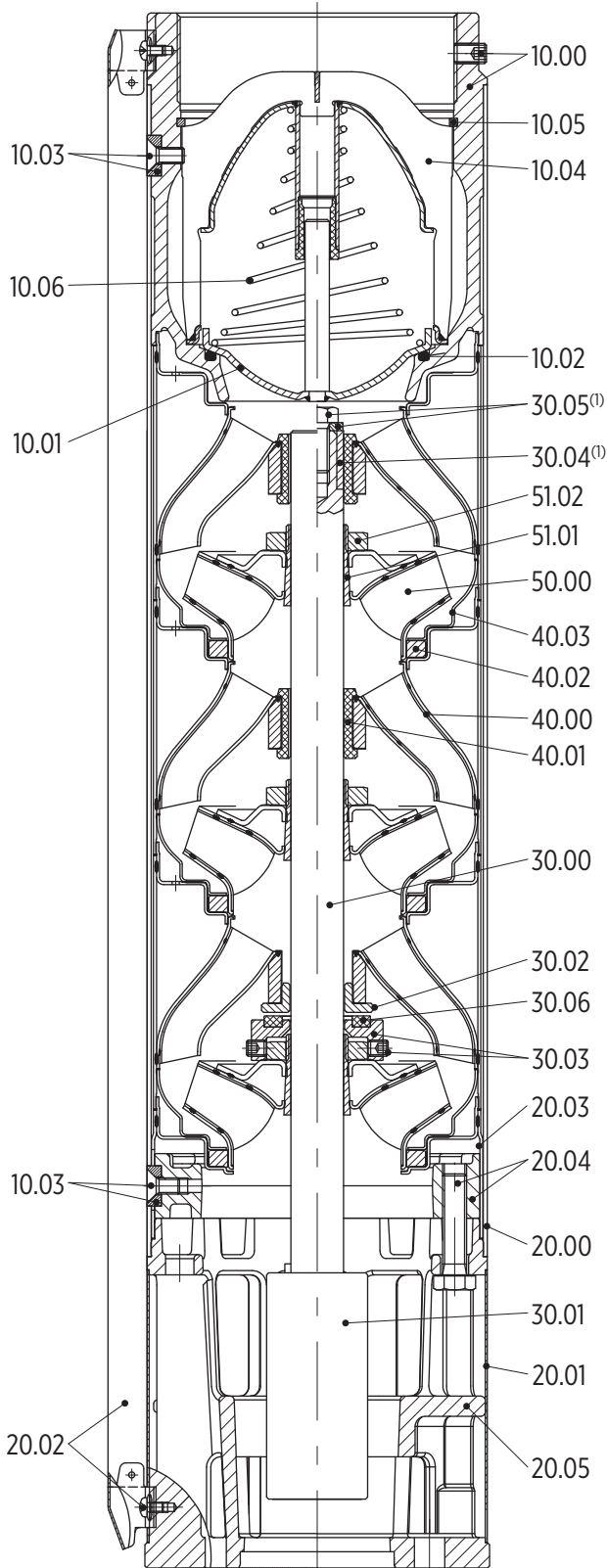

Ref. N.	Description
10.00	Discharge head
10.01	Valve
10.02	Sealing O-ring
10.03	Outer case locking nuts
10.04	Valve support
10.05	Seeger ring
20.00	Outer case
20.01	Suction strainer
20.02	Cable guard and screws
20.03	Initial spacer
20.04	Flange
	Screws
20.05	Motor adapter
30.00	Pump shaft
30.01	Coupling
30.02	Upper up-thrustwasher
30.03	Lower up-thrust washer
30.04	Upper journal sleeve ⁽¹⁾
30.05	Screw and washer ⁽¹⁾
30.06	Up-thrust ring
40.00	Diffuser
40.01	Secondary bearing bush
40.02	Floating neck ring
40.03	Flange clamping neck ring
50.00	Impeller
51.01	Split cone
51.02	Split cone nut

1) only for types with more than 8 stages

0030061 09/2017

MOTOR ADAPTER AND DIMENSIONS

VS 78-97

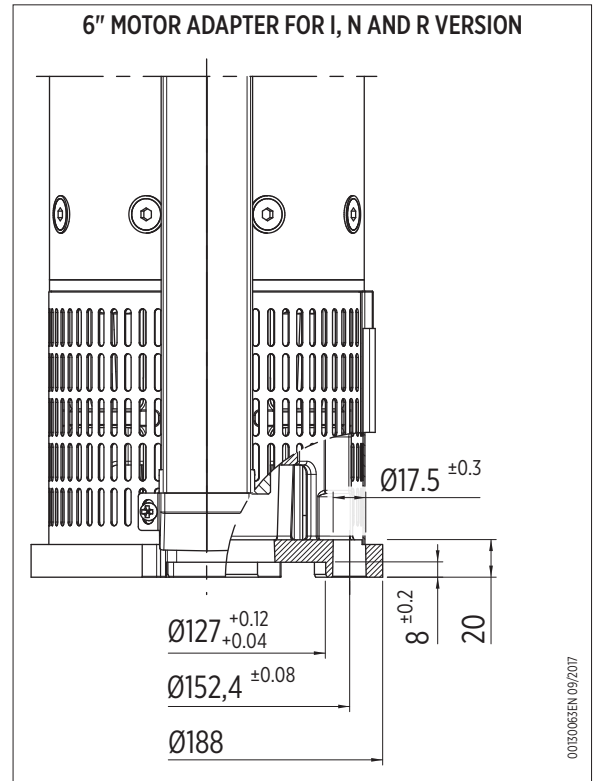
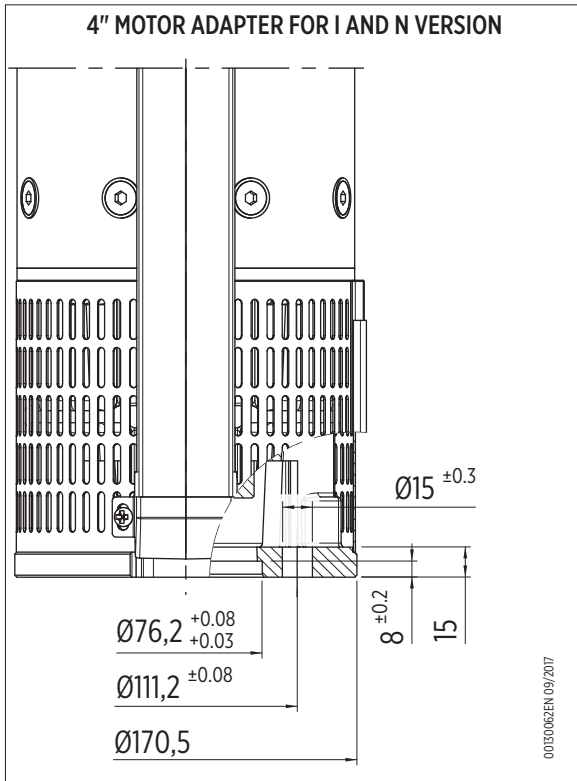



CATALOG REVISION CHANGES NOTICE

Rev. No.	Changes	Page
02	Deleted section "Motor and Accessories"	60 ÷ 82 (REV 01)
03	Modified "Table of Hydraulic performace" for VS 8"	49
	Modified "Technical data - pumps with rewindable motor" table for VS 8"	50-52
04	Added notes for 4" motor adapter	14, 20
	Updated general descriptions	4-46
	Updated "Pump identification code"	5, 47
	Updated "Material/fluids compatibility" tables	7, 50
	Updated "Spare parts" list (VS 6")	42, 43
	Added VS25 model	4,5,6,7,10,26-27,43,44



Franklin Electric